

INTRODUCTION TO WOODTURNING

Brian Clifford

INTRODUCTION TO WOODTURNING

Contents at a glance

Introduction and copyright notice

Part One: Some general aspects

Chapter 1: Learning to turn

Chapter 2: The workshop and equipment

Chapter 3: The tools

Chapter 4: Sharpening tools

Chapter 5: Safety

Part Two: Some Important theoretical points

Chapter 6: Making the cut

Chapter 7: The effect of grain and other factors on the cut

Part Three: Spindle turning

Chapter 8: Introduction to spindle turning

Chapter 9: Setting up for practice

Chapter 10: Roughing down

Chapter 11: The planing cut

Chapter 12: The 'V' cut

Chapter 13: Cutting a bead

Chapter 14: Cutting a cove

Chapter 15: Spindle turning -the final cuts

Contents in detail

Introduction and copyright notice

Part One: Some general aspects

Chapter 1: Learning to turn

- 1.1 The art of woodturning
- 1.2 The learning curve
- 1.3 Developing skills
- 1.4 The basic principles
- 1.5 The pleasure of woodturning

Chapter 2: The workshop and equipment

- 2.1 The workshop
- 2.2 Moving equipment
- 2.3 A separate workshop
- 2.4 The electricity supply
- 2.5 The equipment

Chapter 3: The tools

- 3.1 Introduction
- 3.2 Scrapers
- 3.3 Chisels
- 3.4 Parting tools
- 3.5 Bowl gouges
- 3.6 Spindle gouges
- 3.7 Roughing-out gouges
- 3.8 Inter-changeability of gouges
- 3.9 The different types of steel
- 3.10 The form of the bevel
- 3.11 The minimum kit of tools

Chapter 4: Sharpening tools

- 4.1 The grinder
- 4.2 The type of wheel
- 4.3 Dressing the wheel
- 4.4 Using the grinder
- 4.5 Overheating the tool
- 4.6 To hone or not to hone
- 4.7 Safety

Chapter 5: Safety

- 5.1 Introduction
- 5.2 Clothing
- 5.3 Hair
- 5.4 Eyes
- 5.5 Wood dust and toxicity
- 5.6 Noise
- 5.7 Physical fitness
- 5.8 Guards
- 5.9 Turning speeds

- 5.10 Checking the work-piece
- 5.11 Adjustment of the tool rest
- 5.12 Polishing
- 5.13 Precautions against a dig-in
- 5.14 Use of the correct tools
- 5.15 The use of other machinery
- 5.16 A clear floor space
- 5.17 Fire
- 5.18 Conclusion

Part Two: Some important theoretical points

Chapter 6: Making the cut

- 6.1 General introduction
- 6.2 The correct stance
- 6.3 The grip
- 6.4 Controlling the cut
- 6.5 Problems caused by a badly sharpened tool
- 6.6 The concept of the rubbing bevel

Chapter 7: Grain and other factors relating to the cut

- 7.1 Introduction
- 7.2 The concept of grain
- 7.3 Cutting along the grain
- 7.4 Cutting end grain
- 7.5 Cutting across the grain
- 7.6: The way the work is held on the lathe and the terminology
- 7.7 The implications of rotation
- 7.8 The slicing cut

Part Three: Spindle turning

Chapter 8: Introduction to spindle turning

- 8.1 The basic cuts
- 8.2 Roughing down
- 8.3 The planing cut
- 8.4 The 'V' cut
- 8.5 The bead
- 8.6 The cove
- 8.7 Blending beads and coves
- 8.8 Squaring the end
- 8.9 Rounding the end
- 8.10 The pummel

Chapter 9: Setting up for practice

- 9.1 The blank
- 9.2 Mounting the blank
- 9.3 The rest
- 9.4 Turning speeds

Chapter 10: Roughing down

- 10.1 Setting up
- 10.2 Preliminary exercise

- 10.3 Making the cut
- 10.4 Repeating the cut
- 10.5 The sequence of operations
- 10.6 The direction of the cut

Chapter 11: The planing cut

- 11.1 Introduction
- 11.2 The chisel
- 11.3 The attitude of the chisel
- 11.4 The cutting point
- 11.5 Preliminary exercises
- 11.6 Trying out the cut
- 11.7 Possible problems
- 11.8 Spiral ribbing

Chapter 12: The 'V' cut

- 12.1 Introduction
- 12.2 The swing cut
- 12.3 Points to note
- 12.4 Summary of points to watch
- 12.5 The push method
- 12.6 A comparison of the swing and push cuts
- 12.7 Problems and accidents

Chapter 13: Cutting a bead

- 13.1 Which tool?
- 13.2 The nature of the cut
- 13.3 The procedure
- 13.4 The bevel must rub
- 13.5 The first cut
- 13.6 Forming the bead
- 13.7 The tool must slide along the rest
- 13.8 The problems to be faced
- 13.9 Using a spindle gouge
- 13.10 Try, and try again

Chapter 14: Cutting a cove

- 14.1 Preparation
- 14.2 The tool
- 14.3 The shape of the cove
- 14.4 Marking the size of the cove
- 14.5 The first stage in making the cut
- 14.6 The second stage in making the cove
- 14.7 Preparation for stage two
- 14.8 Beginning stage two
- 14.9 Practising the cut with the lathe switched off
- 14.10 Some further considerations
- 14.11 Discontinuous cuts
- 14.12 Cutting with the leading edge of the tool
- 14.13 Cutting the wood in the centre of the cove

Chapter 15: Spindle turning -the final cuts

15.1 Introduction

15.2 Forming a pummel

15.3 Forming a pummel - method 1

15.4 Forming a pummel - method 2

15.5 Creating the waste

15.6 Rounding the end

15.7 Squaring the end - the conventional cut

15.8 Squaring the end - the Raffan cut

15.9 The parting cut

Introduction and copyright notice

Introduction

This e-book can be read on screen but it will probably be easier to use if it is printed out. It can then be stored in a four-ring, or similar, binder and accessed in the workshop, or elsewhere, at the reader's convenience.

Unauthorised use of this document

In January 2008 my attention was drawn to the fact that this e-book was being sold as a download on eBay. This was done without my consent and I took action to have the listing removed. I wish to make it clear that I have not authorised anyone to use my pages except as set out in the **copyright notice** below. This document and all of the other material on my website is provided free of charge.

The website can be found at www.turningtools.co.uk. More information on woodturning and related matters can be found there.

If any reader should come across misuse of my material I will be very grateful if they will tell me about it. My email address is mail@turningtools.co.uk.

Copyright notice

Visitors are invited to reproduce pages from this pdf or my website, in part or in full, subject to the following conditions:

1. The information is not used for commercial purposes or as an aid to promoting commercial activities.
 2. No changes are made to the text or images.
 3. Both, the ownership of the copyright and the source (ie Brian Clifford at www.turningtools.co.uk) are clearly acknowledged.
-

Part One

Some General Aspects

Chapter 1: Learning to turn

1.1 The art of woodturning

Woodturning is an art not a science. Each skilled practitioner has his own particular way of doing things. The reason for this is that wood unlike, say, metal or plastic, is not an homogeneous substance. No two pieces of wood are identical even when cut from adjacent positions in the tree. In contrast, consider a piece of steel to be used in a motor car. Numerous metallurgists, and other specialists, will have been employed in the production and testing of the steel, to ensure that it has the required characteristics, and that these will be consistent from one batch of material to another. This means that properties such as its granular structure, its hardness, its elasticity and its tensile strength will be the same for every sample.

Wood is not at all like that. Adjacent pieces will exhibit differences in such features as fibre structure, grain pattern, hardness and elasticity. As each unique work piece spins on the lathe and is traversed by the tool the turner has to make subtle adjustments to his technique as he is presented with a stream of changing information. To add to the choices which have to be made a variety of tools can be used to achieve the same basic forms and these tools can be ground to a variety of shapes and bevel angles. Even the lathes that turners use can affect their style. As turners develop their skills so they find their own solutions to the problems they encounter, and blend together the various tools and techniques they have at their disposal in their own unique ways.

One unfortunate result of the development of individual styles is that beginners can be confused by an apparent conflict in instructions in teaching manuals, methods used in demonstrations, and even in techniques shown in woodturning videos. The beginner should not be upset by this. Underlying this variety there are certain principles which are followed by all successful turners and which enable the novice to experiment and to explore different techniques with confidence and without danger. These principles and the way they can be applied to different situations and different tools are set out in the following chapters.

However, because there are a variety of ways to tackle problems, I, like everybody else, have my favourite way of doing things. As a consequence the views I will be putting forward may differ from those of other instructors. They are an amalgam of the things I have found to work for me and my own particular attitude to woodturning.

Because of such differences in views there is a principle which I think is very important: one should not make statements in a book of this kind, particularly if they are controversial, without explaining the reasons for them. The reader (or listener) should always treat unsupported assertions with suspicion.

1.2 The learning curve

Turning requires manual dexterity, visual judgement and the co-ordination of hand and eye. In this respect it is similar to games like tennis. Such activities require the development of what psychologists term 'motor skills'. The learning and development of these skills require relatively long periods of practice.

It has been said that it can take seven years, working full-time, for a turner with aptitude to reach the peak of his abilities and become fully skilled. But again this should not deter the beginner. What does 'fully skilled' mean? It means that the turner can perform all the operations with speed and accuracy. At the top level, for a professional needing to earn a living, speed is an important ingredient in skill.

This can be illustrated by the so called 'learning curve' which may be familiar to the reader. The general shape of the learning curve is illustrated in Diagram 1.1.

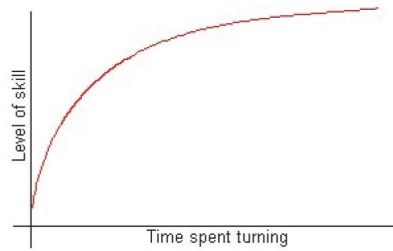

Diagram 1.1 The learning curve

It can be seen from this that typically, with continual practice, the individual goes through a period of steady improvement. Then after some time the rate of improvement begins to level off and eventually there comes a time when very little further improvement takes place. In reality it is found that some individuals have more innate ability than others. Generally, too, where motor skills are involved, it is best to start young. Usually, those who have an early start eventually reach higher levels of skill than older people. But older people should not despair: on their way through life they may well have acquired skills which will be of assistance to their endeavour in the woodturning field.

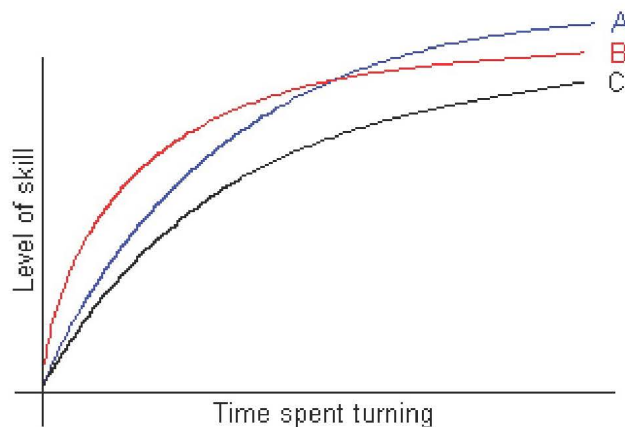

Diagram 1.2 Different learning curves

Because of the differences between individuals, their innate ability, their age, or their previous useful experience, each turner will have his own distinctive learning curve. Some possible, contrasting, curves are shown in Diagram 1.2. Individual C is a very slow learner but he improves little by little. Individual B is a quick learner and reaches his full capacity earlier than individuals A or C. But, although A is a slowish learner, he eventually becomes more skilled than B.

1.3 Developing skills

In the case of woodturning there is a bit more to it than motor skills because, with the right attitude of mind, it is within the power of the individual to alter the shape of the learning curve. The key to skill is attitude. What does this mean? To begin with it means developing an understanding of the correct basic techniques. If the turner does not get the basics right then, however much he practises, he will not improve. In contrast he may develop a lot of bad practices which will be difficult to eradicate.

It is necessary to have a strong desire to learn and progress but at the same time one must have patience. It is no use the turner trying to make things which are way

beyond his level ability, particularly in the early stages. On the other hand it is necessary for him to stretch himself with projects of steadily increasing difficulty. It may be a good idea for the learner to set himself a series of achievable goals.

Nevertheless, it has to be recognised that the hobby turner with only limited time at his disposal is in a different position to the aspiring professional. Learning to turn is like learning to play a musical instrument (although turning is far less difficult). Regular short periods of practice are preferable to periods of intensive effort with big gaps between them. Having said that it must be acknowledged that the hobbyist will have to fit his turning into the free time he has available and do the best he can. Life is full of compromises, and this is one of them.

In developing skills and working out the best way to progress it will be necessary to experiment with the various cuts, tools and techniques. In order to avoid dangerous practices, some caution is required in doing this, but experimentation is a very necessary part of the learning process. However, in the early stages the instructions given in the following chapters should be followed with care.

Whatever his circumstances, and however much time he has available, when the aspiring turner is practising he must keep thinking about what he is doing and asking himself questions. When things go wrong he must ask himself: why? What happened? What can I do to try to ensure it does not happen again? It also helps if the turner can recognise when things are going right, so that he will know what things he can do, as well as those he cannot.

Good turning entails careful observation involving the three main senses: sight, sound, and touch. The eyes are the primary source of information. Obviously, it is necessary to look to see what one is doing, but one should also be watching for the results. What is happening to the shape: is it smooth or is it ridged? Will I be able to blend it into the profile I want? Are the fibres tearing? What else can I see?

Sound provides further important information so it is necessary to keep one's ears open. For example, when a cut is being made correctly there will be a variety of sounds but underneath these it should be possible to hear a relatively quiet, but clearly distinguishable, hiss which is made by the fibres being cut cleanly. The other sounds carry information as well. When I am teaching more than one person at a time I can often tell when someone is having trouble from the sound alone.

Yet more vital information is being transmitted back to the turner through the tool. The turner should try to develop as much sensitivity in the hands as he can, holding the tool as lightly as possible. Even where a firmer grip is required the turner can still feel what is happening as well as see or hear.

In many cases where a cut is not going correctly all three senses will be telling the turner that something is wrong. In other cases just one will be enough. For example, when a hidden split, or other defect, in the wood is encountered there is often a quiet click which warns the turner to stop the lathe to have a look.

In summary, therefore, it can be said that these three senses are providing the turner with a stream of information which has to be continually interpreted. Much of the time, it is to be hoped, the signal will be that all is well, but the turner must be vigilant. By applying himself diligently to the task, developing a sensitivity to the stream of information, continually analysing his actions and their results, and practising as regularly as possible the turner can learn more quickly and will eventually reach a higher level of skill.

1.4 The basic principles

It must be noted, however, that although skill can only be acquired by practice, by "making shavings" as the saying goes, it is futile practising unless the basic principles are being applied. The basic principles are comprised of four main

elements:

- The choice of the correct tools
- The use of properly sharpened tools
- A good stance
- The use of correct cutting techniques

Consideration must also be given to safety. Safe working habits should become habitual and are as much part of basic principles as the four points covered above. Unsafe practices may not prevent good turning but they may cut short a turner's career.

Much of this book is devoted to these basic principles. However, before he can practise the basic principles the prospective turner must provide himself with a certain amount of equipment. At the very minimum this will be a lathe, a grinding machine and a set of tools. He will also need somewhere to keep it and somewhere to work; usually, of course, these are the same place, namely the workshop. The question of a workshop and equipment is discussed in the next chapter and tools in the one after that.

1.5 The pleasure of woodturning

Some of the comments made above may make learning to turn seem daunting but it is not intended to put people off. Anyone, from nine to ninety, male or female, with a modicum of manual dexterity, can learn to turn successfully. Given a reasonable degree of application it will only take most beginners a few hours of practice to learn to make simple but attractive objects which provide immense satisfaction. Many of these objects only take an hour or so to make.

The great pleasure which can be derived from wood turning stems from two things. One is that, whilst very satisfying results can be obtained with relatively little experience, learning and improvement can go on for the rest of a lifetime. The other source of pleasure is that hand turning brings the maker into a very close and intimate relationship with his material. Turners get to know wood as few other people can.

Chapter 2: The workshop and equipment

2.1 The workshop

The first thing anybody taking up woodturning must contemplate is where they are going to put their lathe and other equipment. This obviously depends on the size and amount of the equipment and the working space required. But there are other considerations. The three most important are questions of noise, dust and security.

I have heard of turning being carried out in locations as diverse as a flat, an attic and a greenhouse. To some extent, therefore, the location of the workshop depends on the ingenuity and determination of the turner. However, in the discussion which follows I am going to assume that the workshop will be somewhere outside the house (or domestic area).

Woodturning itself, that is to say work on the lathe, is not very noisy, but some of the activities which are associated with it can be a cause of nuisance. How much noise can be tolerated by the family and the neighbours depends partly on their life styles and characters and partly on the amount of noise coming from the general environment. The attitude to noise of people living under the flight path of Heathrow or near a busy motorway will be different to that of those living in a quiet close on the outskirts of town. I know from experience that noise, or other people's perception of noise, can cause problems and needs to be considered.

Woodturning causes a good deal of mess. Not dirty dirt but lots of dust and small shavings. This can be reduced by the use of a dust extractor but cannot, by any means, be eliminated. This may cause problems if the woodturning is to share workshop space with some other activity.

It should be mentioned in passing that shavings refuse to be confined to the workshop; even when protective clothing is worn they find their way into pockets, shoes, underclothing and all sorts of unlikely places, and are subsequently deposited all over the house. The only way I have found to deal with this menace is to keep a rechargeable handheld vacuum cleaner in a convenient place with which to pick up the offending particles. Nevertheless, unless one has a tolerant partner, the emergence of errant shavings can easily be a source of conflict. I admit I find them a nuisance myself, but this nuisance is a small price to pay for the pleasure of turning.

It is difficult to say what is the minimum size for a workshop. In some cases it depends on whether the space is to be shared with another activity or whether some ancillary equipment can be located elsewhere. At the minimum the working space must house a lathe and a grinder and provide the turner with sufficient room to manipulate the tools. As there are some very small lathes on the market a bench space, of say, 3ft by 1ft might be sufficient. This would, however, limit the turner to very small work. So, as with many other activities, the turner's requirements in respect to space and equipment depends on his aspirations and his resources. The result is likely to be some sort of compromise. There are two basic ways of looking at this problem. The turner could look at the work space available and ask: "what can I get into here?" Or he could decide what equipment he would like and then ask: "how much space do I need and how am I going to find it?" The most likely approach, however, is some combination of these. In practice many aspiring turners see the garage as the obvious place to use; but this space may also have to be share with the family car, the garden tools, the lawn mower and, possibly, some other large item such as a freezer

2.2 Moving equipment

The use of the garage has one advantage over other places in that cars are designed to be moved. So, even if the car is not permanently banished from the garage, it can be moved outside whilst turning is in progress. However, when the car is in the garage the space for storing equipment may be very limited. As a consequence it may be necessary to move equipment back and forth from a storage position to a working position. If this is not to deter its use it needs to be done as easily as possible.

The means of achieving this may be applicable to other restricted working spaces so some ideas are set out in this paragraph. The most obvious way of making items easier to move is to put them on wheels. Industrial castors, which can be obtained from the larger DIY stores, are ideal. If the item is not too heavy it might be enough to put a pair of castors under one end only. In the case of a lathe this would be under the headstock end which is always the heaviest. However, lathes in particular, need to be mounted so that they are free of vibration, and castors may cause a problem in this respect.

The answer to this problem is to have some means of lifting the whole assembly off the ground and inserting something solid, such as block of timber, under the bench so that the castors are clear of the ground. A lever could be used to lift the end of the assembly whilst a block is inserted, but one person might find this difficult on his own. An alternative would be to use a car jack. A neat idea would be to have a jack permanently attached to the bench so that it could be wound up and down quickly and easily.

2.3 A separate workshop

Many turners, like myself, start off in the garage and then aspire to a space which can be dedicated to turning. Others may decide to start as they mean to carry on and set up a separate workshop from the outset. Not many are fortunate enough to be able to have a brick (or similar solid structure) to house their precious equipment. But some can afford a wooden shed. As a place to work in this is fine, particularly if it is well insulated. I use one myself.

There are, however, two possible problems with a timber building: fire risk and security. Some insurers will not consider such buildings for these reasons. If care is taken the fire risk should not be very terrible, but security is another matter. It is very difficult to make the typical shed secure against a determined thief. Having said that my only experience of theft happened when thieves broke into a workshop which was in a brick building with a strong door secured with a heavy padlock. The thieves cut the lock off with bolt cutters. This workshop was in a museum and was open to the public in the daytime but was deserted at night - the worst possible situation. They took all my powered hand-tools: hundreds of pounds worth of drills, saws, a router, and similar items. But they took no turning tools, and no big items such as lathes or a dust extractor. It is possible the thieves might have come back for more but I immediately vacated this workshop.

What conclusions can one draw from this? One, is that security is affected by the environment. Another, possibly, is that turning tools are relatively unattractive to thieves because they are difficult to dispose of. In addition, the large pieces of equipment will be left alone by the casual thief but will not always be safe.

I learned three important things from my experience. One is to keep the existence of the workshop known to as few people as possible. Another is to keep the more expensive hand tools out of the workshop in a more secure place. In case all

precautions prove futile it is advisable to take out insurance. The Association of Woodturners of Great Britain (AWGB) run an excellent scheme in conjunction with insurance brokers which provides the relevant cover at very competitive rates. Membership of the Association is worth the money for this alone.

2.4 The electricity supply

Whatever space is used for the workshop it will be necessary to ensure that the electricity supply is safe and adequate. Ideally, a qualified electrician should be consulted. In any event there are two suggestions I would make. Try to run all the equipment through one double pole switch of the required amperage. On leaving the workshop at the end of a session this can be switched off, so making sure that every piece of equipment is isolated from the mains supply. Many workshops have a concrete floor which can be a source of danger from electric shock - this danger can be reduced by fitting an earth trip.

Lighting is another thing which needs to be considered. Fluorescent tubes are good for general lighting but many turners prefer tungsten lights over the lathe. Stroboscopic effects can often be a nuisance (or even dangerous) when turning - tungsten light is better in this respect. It also provides lighting which is less flat than that from fluorescent tubes. Shadows help turners to see what is happening on the surface of their work and to spot defects.

2.5 The equipment

The most obvious piece of equipment required for the prospective turner is of course a lathe. There is a variety of lathes on the market today. With lathes, as with many other things, you get what you pay for, but even the cheapest lathe may represent a considerable outlay for the person with only limited funds to spend on a hobby. Unfortunately, expenditure does not stop at the lathe. Two other things are essential: a basic set of tools (see Chapter 3) and a grinder (see Chapter 4). Once the beginner has learned the basic techniques, and gained some confidence, a number of other purchases will begin to beckon. These will include a scroll chuck, a bench drill, and sundry small items such as callipers, and a dressing stone for the grinding wheels.

Other things which may appear on the wish list will be a Jacobs' chuck, a band-saw and a long-hole boring kit. And, of course, some suitable wood will be required. I mention these things because they add considerably to the expense. The prospective turner is liable to fail to take this into consideration. It needs to be borne in mind. Some points can be made about the choice of some of these items. First and foremost: the lathe. Rule number one is to buy the biggest lathe one can afford: whilst the smallest items can be turned on a big lathe, large items cannot be turned on a small lathe. If a suitable second-hand lathe can be found so much the better. A lathe is a pretty basic piece of machinery; as long as the bearings are in good condition, and the tailstock aligns properly with the headstock, there is not much more to worry about. If it later becomes necessary to sell the lathe, either because it is not used or the owner wishes to upgrade to a better one, then very little money should be lost.

Bowl turning will require a larger lathe than spindle turning. It also needs to be borne in mind that bowl turning is difficult over the bed of the lathe (particularly for a left-handed person) and that the maximum size of the bowl that can be turned is determined by the distance between the drive centre and the bed bars. For bowl turning the lathe will ideally have an outboard turning facility or a swing head.

Outboard turning arrangements require an extension of the drive shaft on the left-hand side of the headstock so that the turner can work on that side. This has two disadvantages: (1) a considerable amount of space is required to the left of the lathe; and (2) when viewed from the left-hand side the head will be seen to be rotating clockwise. The latter point means that the shaft on the outboard side, and face plates and chucks to be used on it, have a reverse thread. This leads to additional expense. Because of the disadvantages of the arrangements for outboard turning the swing head has become more popular and most new lathes of any size have this facility.

Other considerations when buying a lathe are the choice between fixed speeds or variable speeds, as well as the speed range. An important aspect for the turner who wishes to turn large bowls is the availability of a low speed. The most expensive option, but the best, is the electronic variable speed, as long as it provides sufficient torque at the bottom end of the range. Otherwise (given the availability of similar speeds at the low end) there is probably not a lot to choose between 5 or more speeds on a pulley system and a mechanical variable speed system. There is another proviso, that the speeds on a fixed pulley system should be easy to change.

The cheaper lathes have only 3 speeds on a fixed pulley system. This has its limitation in terms of control over the work but nevertheless many turners manage with it quite adequately. It does help if the 3 speeds provided cover a suitable range. The first lathe I bought had only three speeds: 750, 1500, and 3000 rpm. In my view this was a very poor selection particularly as this lathe had a generous 9in swing. Given just three speeds a much better selection would have been something like 500 (or lower if possible), 1250 and 2000 rpm.

Often, the problem is that the lowest speed is determined by limitations on the sizes of the smallest and largest pulleys. The smallest pulley must be large enough to fit on the motor shaft and the largest must fit inside the headstock casing. It should be remembered that most motors for lathes run at 1500 rpm. As a consequence the choice of the lowest speed is determined by the size of the largest pulley which will fit into the headstock.

Factors such as the length of the bed and the power of the motor depend on the type of turning which will be undertaken. Without knowing about this it is difficult to generalise.

A check list of points to consider when buying a lathe is provided on the following page

CHOOSING A LATHE

Purchasing

- A. New or second-hand
 - 1. Second-hand
 - i. Well worth considering -it will depreciate slower than a new one
 - ii. Check condition
 - a. Alignment of headstock and tailstock
 - b. State of bearings
 - 2. New
 - i. You tend to get what you pay for but some better value than others - shop around

Design and Construction

- B. Weight
- C. Rigidity
- D. Strength of bearings
- E. Distance between bearings in headstock
- F. Power of motor
- G. Is there a Morse taper in the headstock?
- H. Diameter of swing
- I. Length of bed
- L. Has it a fixed head only?
- M. Arrangements for bowl turning
 - 1. Outboard
 - i. Direction of revolution
 - ii. Right-hand thread
 - 2. Rotating headstock
 - 3. Space requirements are different for 1 & 2 above
 - 4. Additional cost of attachments for bowl turning

Speeds

- 1. Number (five is best, if speed is not continuously variable)
- 2. Speed range
- 3. Ease of changing speeds
- N. Ease of adjustment to rest and tailstock
- O. Portability (if important)
- P. Spares and ancillary equipment
 - 1. Availability
 - 2. Nose spindle thread
- Q. The final choice will be a compromise depending on:
 - 1. Available funds
 - 2. Working space
 - 3. General requirements
 - 4. Except for people doing miniature work a big lathe is preferable to a small lathe - small items (eg lace bobbins) can be turned on a big lathe - big items cannot be turned on a small lathe
- R. No lathe is perfect!

Chapter 3: The tools

3.1 Introduction

The range of woodturning tools on the market today is enormous. Ashley Lies, for example, produce 350 different woodturning tools. These are all standard tools made in a range of sizes in carbon steel or high speed steel. In addition a number of manufacturers are making some highly specialised (and very expensive) tools, such as the Stewart System. Most beginners, however, will only be able to afford a limited number of standard tools so they will have to make some careful choices. My suggestions for the minimum basic set of tools is given at the end of this chapter.

But, before coming to the choice of tools the beginner needs to understand the functions of the different types and the reasons for some relatively subtle differences in shape and form. The difference between carbon steel and high speed steel also needs to be understood.

When I started turning at the beginning of the eighties only carbon steel tools were available, but since then high speed steel turning tools have become ubiquitous. High speed steel, which is harder than carbon steel, was originally developed to enable higher cutting speeds to be used when machining metal. Because of this high speed steel tools retain their edge longer on wood. Nevertheless, each type of steel has its advantages and disadvantages. These are discussed later in this chapter.

There are three principal types of tool: scrapers, chisels, and gouges. Gouges can be subdivided into three further types: bowl gouges, spindle gouges, and roughing out gouges. Chisels and gouges are usually described as cutting tools, because they are designed to sever rather than break, or tear, the wood fibres. In contrast scrapers are often perceived as crude tools which simply tear out a shaving. However, when employed with care, and the correct technique, scrapers can be used to sever the fibres and leave a good finish. It must be pointed out, too, that chisels can, on occasion, be used for scraping.

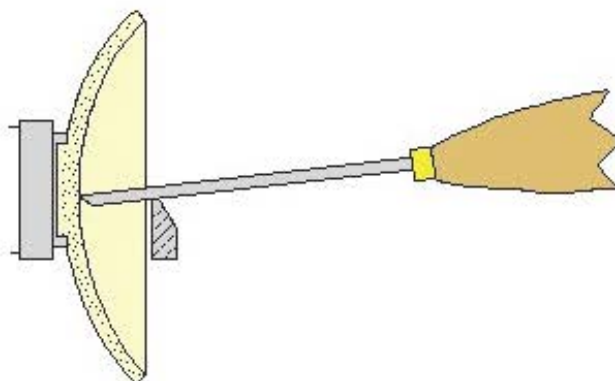

Diagram 3.1 Attitude of scraper in use

However, there is a clear distinction which can be made between chisels and gouges, on the one hand, and scrapers, on the other. This concerns the attitude in which they are used. When employed in the cutting mode chisels and gouges are used with the bevel rubbing and the wood moving onto the edge of the tool (see also

Chapter 6). In contrast scrapers must never be used with the bevel rubbing and the edge must be trailing. Except in very special circumstances this means that a scraper must be used with the tool pointing downwards. (See Diagram 3.1) If a chisel is used for scraping it must also be held pointing downwards.

These distinctions will become clearer when the ways the tools are used are described in the chapters which follow. The description of the shapes of the tools will also help to clarify matters.

3.2 Scrapers

Scrapers are mostly made from rectangular bar and are usually ground with a large bevel angle. The size of the bevel angle is not critical, however, and some turners may make it relatively small. Like a chisel, the cutting edge of a scraper can be skewed, but it can also be a variety of other shapes. Some of the most common, which a beginner may wish to use, are shown in Diagram 3.2. They can be made from either carbon steel or high speed steel and the same shapes are used in both materials.

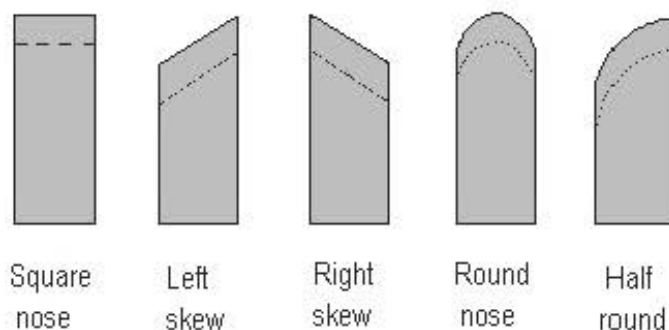

Diagram 3.2 Some shapes for scrapers

3.3 Chisels

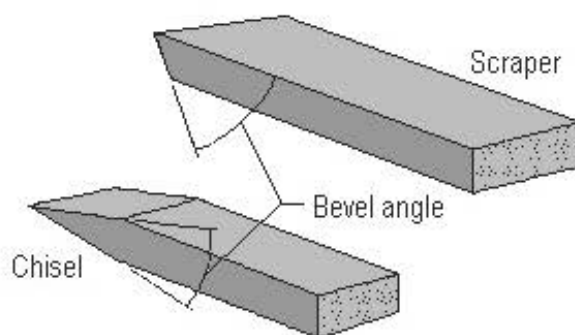

Diagram 3.3 Bevels on chisels and scrapers

Like scrapers chisels are often made from rectangular bar but the bevels are ground differently. Chisels usually have double bevels, and the bevel angles are smaller than those normally used on scrapers (see Diagram 3.3). The cutting edge of a chisel can either be ground square across or it can be skewed (see Diagram 3.4).

Carbon steel chisels have always been made with a rectangular cross-section. High speed steel skew chisels can also have a rectangular cross-section. Some, however, are made slightly oval in section with one edge rounded (see Diagram

3.5, section A-A). In the smaller sizes this can make them a little flimsy, particularly when they are made overlong. Until recently the cutting edge of a skew chisel was always ground so that it was straight (as in Diagram 3.4) but in recent years some turners have made it curved (as in Diagram 3.5).

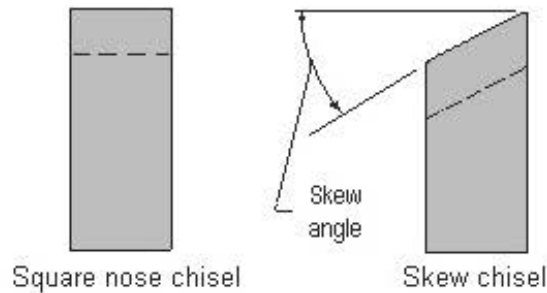

Diagram 3.4 Square and skewed edge chisels

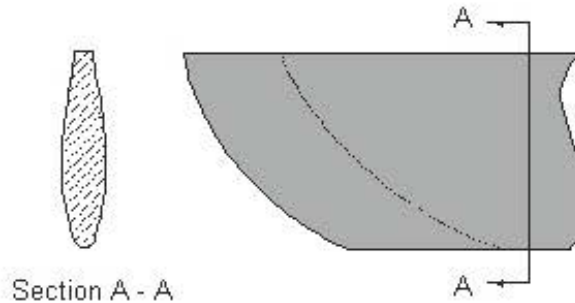

Diagram 3.5 Oval section HSS chisel with curved cutting edge

3.4 Parting tools

Parting tools are narrow chisels. In principle, as their name suggests, they are used for separating the waste material from either end of the finished piece of work. In practice they have a number of other uses. They come in a variety of shapes and sizes, some of which are shown in diagram 3.6.

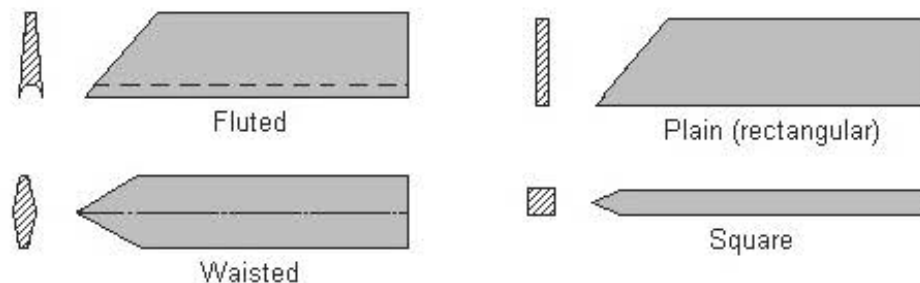

Diagram 3.6 Parting tools

3.5 Bowl gouges

Because bowl gouges are often used with a long overhang between the cutting edge and the rest they need to be stiff and strong so that they will not bend or flex in use. Books written before high speed steel came into use refer to the 'long and strong' bowl gouge. This is a carbon steel gouge which has a deep 'U' section. It has been superseded by the high speed steel bowl gouge which is made by milling a flute into round bar. This gives a very different cross-section (see Diagram 3.7).

The long and strong carbon steel bowl gouges were ground so that the cutting edge was square to the axis of the tool, as shown in Diagram 3.7. Also shown in this diagram is the shape of the a high speed steel bowl gouge. It can be seen that in this case the wings are ground back. The way this is achieved is described under sharpening below. (See Section 4.4)

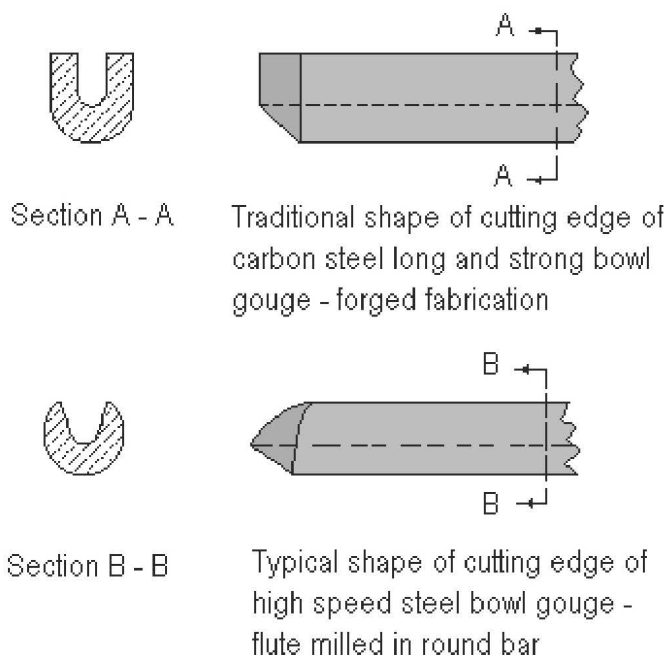

Diagram 3.7 Bowl gouges

Sizes normally refer to widths but high speed steel bowl gouges are measured in a very peculiar way: from the inside of the flute to the outside of the bar (see Diagram 3.8). Although these tools have only been available for a few years the reason for the way in which they are measured seems to have been lost in the mists of time. Anyway, the unfortunate result of this system is that, in effect, here are no standard sizes. Differences in the size of the flute in relation to the diameter of the bar can lead to very different gouges with the same nominal size.

Note that it is the size of the flute which really determines the size of the tool. The relationship between the size of the flute and the diameter of the bar determines the strength of the tool. There are in practice quite substantial differences in this relationship between manufacturers and I suggest that when building up a set of bowl gouges an attempt should be made to stick to a single brand.

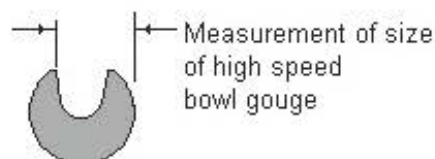

Diagram 3.8 Measurement of size of HSS bowl gouge

3.6 Spindle gouges

Carbon steel spindle gouges are forged from flat bar to form the cross-section shown in Diagram 3.9. High speed steel spindle gouges can be produced in the same way but they are more commonly made by milling the flute from round bar in a similar way to bowl gouges. The flutes in spindle gouges are, however, much larger than those in bowl gouges relative to the size of the bar. This provides a slimmer tool which can enter the more restricted spaces encountered in spindle turning. The shape of the cutting edge of a spindle gouge has traditionally been described as a fingernail shape, that is, half an ellipse (see Diagram 3.9).

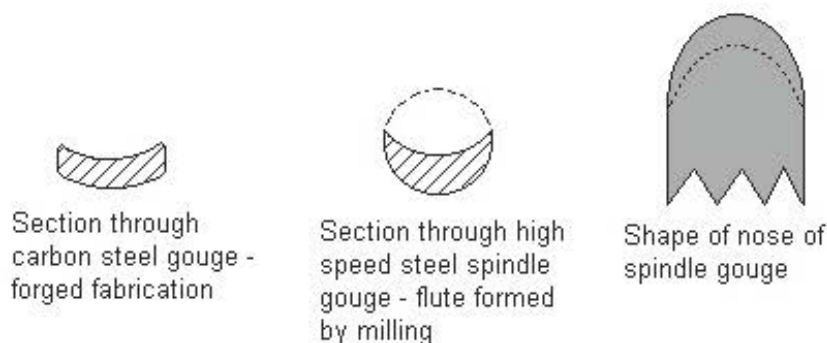

Diagram 3.9 Shape of spindle gouge

3.7 Roughing-out gouges

Roughing gouges are used in the preliminary stages of spindle turning (as described in Chapter 9) They are normally much larger than bowl or spindle gouges and it is important to note they should never be used to shape bowls. They are made by forging or pressing flat bar into a half-round section. Some manufacturers of high speed roughing gouges extend the wings a little to form a 'U' section which flares out slightly.

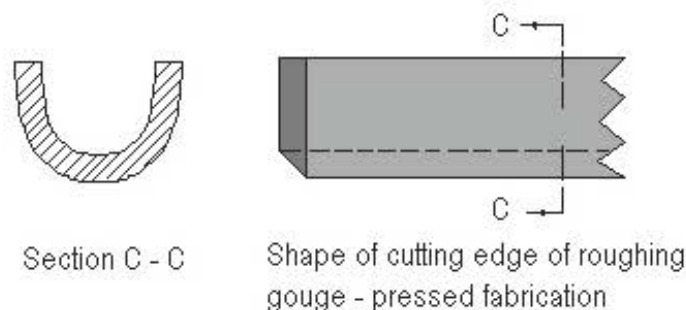

Diagram 3.10 Shape of roughing gouge

3.8 Inter-changeability of gouges

It is quite common today to find a high speed steel bowl gouge used to perform the function of a spindle gouge. I do this quite frequently myself. The reason for this is that when both types of gouge are made from round bar there is not a lot of difference in the shape of the cutting edges. But there is one important difference which should be noted: for a given size of cutting tip (which is related to the size of the flute) a bowl gouge is very much stronger than a spindle gouge. As a consequence, although a bowl gouge may be used for spindle turning a spindle gouge should not (normally) be used for bowl turning.

3.9 The different types of steel

It is often said that high speed steel tools are easier to sharpen (on a grinding wheel) than carbon steel. The justification given for this statement is that it is less easy to overheat and soften the edge of a high speed steel tool. Although that is true, they also take longer to sharpen (because they are harder) which can make it more difficult to get the desired shape. It is also said that high speed steel tools last longer. This, too, is true, but they are also a lot more expensive. And how long does one want a tool to last? I have been using my 1¼ in carbon steel skew chisel for eighteen years and I still have more than half the length left.

So, we come to a contentious point. Nowadays, some turners will only use high speed steel tools, and some stockists do not sell carbon steel tools. Nevertheless, I always advise beginners to buy a mixture of high speed and carbon steel tools.

Because of the edge retaining properties of high speed steel I certainly believe it is best for bowl and spindle gouges. The high speed steel bowl gouges are also made from round bar which also provides a better shape than the old, forged, carbon steel forms. For skew chisels and scrapers I find that the edge retaining qualities of high speed steel are not so important. So, for these, I recommend carbon steel; they are easier to sharpen, they are cheaper, and they will last as long as necessary.

3.10 The form of the bevel

The bevel on cutting tools, ie chisels, gouges and parting tools, must be the correct shape: either hollow ground (concave) or flat, it should never be rounded (convex). If the bevel on a tool is rounded it will very difficult, if not impossible, to use it without digging in. (The reasons for this are explained in detail in Chapter 6.) So it is vitally important to get the bevel right. Many novice turners get it wrong; I have seen a lot of tools it would be impossible to use successfully.

There is also the question of the bevel angle to consider. The size of bevel angles is by no means as critical as many pundits would suggest. One aspect of this is that bevel angles are often expressed as a precise number of degrees. In practice it is pretty well impossible to grind, and to measure, with that degree of accuracy. It certainly is not necessary. There is wide disagreement among skilled turners regarding the bevel angles for specific tools. For example, one book on my shelves suggests that the bevel angle for a skew chisel should be 12° (that is 12.5° on each side!) and another suggests that it should be 45°. The truth of the matter, probably, is that skew chisels can be used successfully with bevel angles anywhere between these two figures.

A wide range of bevel angles can be used on bowl gouges without experiencing problems although the most satisfactory angle tends to depend on circumstances. For example, it may be necessary to use a bowl gouge with a large bevel angle (eg 60°) to turn the bottom of the inside of a deep bowl. However, a bevel angle of 40° to 45° will serve for many circumstances. Other angles can be experimented with when the

turner feels inclined. In general slightly smaller bevel angles can be recommended for spindle gouges. If the spindle gouge is to be used for cutting beads then a small bevel angle is required so that the tool can be introduced into small spaces.

Generally speaking, however, I believe that tools with relatively large bevel angles are easier for the novice to use than the reverse. Tools with small bevel angles tend to be 'grabby', that is to say they have a tendency to bite into the wood. This is particularly true of chisels. In my view most manufacturers supply chisels with the bevel ground to too small an angle. For my students I grind the chisels to a bevel angle of around 45°. But any angle between 35° and 45° will be satisfactory.

3.11 The minimum kit of tools

I would say that the minimum number of tools required to start with is ten. I bought a boxed set of that number when I started turning, more by luck than judgement, and I have never found any reason to think that was a wrong decision. The beginners set of mixed high speed and carbon steel tools I would recommend is made up as follows:

High speed steel

- 3/8 in. bowl gouge
- 1/4 in. bowl gouge
- 1/2 in. spindle gouge
- 1/4 in. spindle gouge

Carbon steel

- 3/4 in. roughing gouge
- 1 1/4 in. skew chisel
- 1 1/4 in. square nose scraper
- 1/2 in. square nose scraper
- 3/4 in. round nose scraper
- 3/8 in. square beading and parting tool
- 1/8 in. plain parting tool

It will have been noticed that this list contains 11 tools. This is because I have added the 1/8 in. plain parting tool to my original list - it is a very useful tool. My choice of a carbon steel skew chisel may surprise and irritate a lot of turners. The oval, high speed steel, skew chisel has many devotees. I can only say that I am not enthralled with it, but that is probably a personal idiosyncrasy.

Chapter 4: Sharpening tools

4.1 The grinder

Once some tools have been acquired they must be sharpened correctly. To do this a grinder will be required. All that most amateurs need is a relatively cheap machine with two 6in. wheels, a coarse and a fine. At the time of writing new machines can be purchased for as little as £20. More expensive machines with water cooled wheels are available but these entail unnecessary additional expenditure.

4.2 The type of wheel

It is likely that a cheap grinder will be supplied with two Carborundum wheels, which are grey in colour. The coarse wheel will probably be 30 grit and the fine wheel 60 grit. These wheels will be suitable for sharpening carbon steel tools but, if high speed steel tools are to be used, then the 60 grit wheel should be replaced by one made of aluminium oxide. This is often called a white wheel because of its colour. These wheels work satisfactorily with carbon steel as well so they can be used for both types of tool. It would be worth asking the suppliers if they can provide the machine with an aluminium oxide wheel; if the change is made by the purchaser the Carborundum wheel is redundant and is a waste of money.

Another, important reason, for asking the supplier to change the wheel is that, by law, wheels should be fitted only by someone who has been correctly trained to do so and has a certificate to prove it. A damaged grinding wheel, such as one which is cracked because it has been dropped or badly fitted, is a very dangerous object. Grinding wheels can, and do, explode into pieces in use. Since the operator will probably be standing in the firing line when this happens the results can be horrific. Such accidents are rare, but it pays to be careful.

A new wheel will have a label attached which gives the specification. The wheel I bought for my machine is marked as follows: 180x25x31.75 BA60PV. The first three figures refer to the size of the wheel in millimetres. The first letter (B) is the makers own mark. The second letter (A) indicates the type of abrasive. 'A' stands for aluminium oxide. If it was 'C' it would be Carborundum (ie silicon carbide). The number (60) indicates the grit size. The third letter (P) indicates the hardness of the non-abrasive material which binds the grit into the wheel. This ranges from 'E' which is soft, to 'Z' which is hard. The binding material on my wheel is therefore right in the middle of the range so it is of medium hardness. The final letter (V) indicates the nature of the binding material. In this case 'V' stands for vitrified. It could also be 'R' for rubber or 'E' for shellac.

4.3 Dressing the wheel

In order to reduce the possibility of overheating the tool, and to make the sharpening process as efficient as possible, the grinding wheel must be kept in good condition. If it is not dressed regularly the edges of the silicon carbide or aluminium oxide granules in the wheel lose their edges and the little crevices between them get filled with particles of dust. This gives the surface a glazed appearance which can be seen when the light strikes it at the an angle. In this condition the wheel is inefficient and satisfactory sharpening is difficult, if not impossible.

There are a number of devices used for dressing a wheel. One of these is called a star wheel. Personally, I dislike this device intensely because it seems so crude and dangerous. This leaves two alternatives: a Carborundum stick or a diamond tool. A Carborundum stick is cheap and effective. It is used with the machine running: with

the stick supported by the tool rest, one of the edges at the end is passed firmly across the face of the wheel so as to remove the glazed surface. A diamond dressing tool can be somewhat more expensive but it does the job very efficiently. A simple little jig may be required to ensure that the diamond is passed across the wheel so as to give a smooth, square, surface.

4.4 Using the grinder

The ability to produce a sharp edge on a tool is a very important aspect of turning. Unfortunately there is even less uniformity of method in sharpening than there is in turning itself. If the opportunity can be taken to watch a variety of turners' sharpening tools, either at demonstrations or on videos, it will be seen that some very different methods are used.

Many novice turners find sharpening on the grinding wheel difficult. The problem is in achieving a well formed bevel without burning the tool. Various aids, such as the use of special jigs, can be used to help hold the tool at the correct angle but these do have certain disadvantages. They can be slow and awkward to use and the turner can come to rely on them to an undesirable extent. If he should find himself in a situation away from his own workshop, without his usual aids, he may be unable to sharpen his tools satisfactorily. It is better to learn how to sharpen your tools without any special devices. Having said that, however, it is vital that beginners should be confident that their tools are sharp and correctly ground; if it is found that some kind of jig is necessary to ensure this, then use one. More information on the correct form for the bevel is given in Chapter 3, Section 10.3, and in Chapter 6.

My own methods (which may be a little unusual) are as follows. The only tool I support directly on the tool rest is the scraper. I set the rest so that scrapers can be laid flat on it at the correct angle. A scraper can then be sharpened very quickly with just a touch on the wheel. The other tools, chisels and gouges, I hold high on the wheel with the underneath hand (my left) supported by the rest.

These methods can be employed more readily if the tool rest is bigger than those normally fitted to small grinders and made so that its angle can be adjusted. If the rest is reasonably long it makes it easier to sharpen chisels as the hands can then be slid backwards and forwards along it. As a consequence it is necessary to modify the rest on many machines.

High speed steel bowl gouges should pose no special problems. Because they are made from round bar a satisfactory shape can be obtained merely by rotating them in the fingers along their central axis with the bevel resting on the wheel at the correct angle. This produces a cone shape at the end with the flute cutting through it; the required edge shape is then created automatically.

Spindle gouges are a little more difficult to grind because, to produce the finger nail shape, the handle has to be swung from side to side as the tool is rotated along its axis. This requires some practice.

4.5 Overheating the tool

When grinding all tools only the very lightest weight should be applied in order to avoid overheating the edge. Very often the weight of the tool on the grinding wheel provides enough pressure. Prolonged contact between the wheel and the tool should be avoided for the same reason. If considerable reshaping of a tool is required then it must be cooled by dipping the tip in water at frequent intervals. Overheating becomes apparent when the metal turns blue. When this happens to high speed steel it is not too much of a problem since the steel will not have been softened. But when

it happens to carbon steel it means that the temper will have been taken out of the steel and the tool will not hold its edge.

4.6 To hone or not to hone

After sharpening on the grinder tools can be honed with a whetstone. I have found this to be a contentious area. When done by a skilled practitioner honing can save time and prolong the life of the tool. Nevertheless, I do not recommend honing to the beginner. When it is not done skilfully it is very easy to spoil the shape of the bevel by making it slightly convex at the tip.

It may be noted too, that most professional turners in the UK prefer not to hone their tools; they use them straight from the grinding wheel. There are two reasons for this, I think. One is that they find grinding quick and convenient. The other is that a ground edge may, in practice, cut better than one that is honed. I sometimes make some very thin turnings which require very sharp tools; I have tried honing my tools for this but I have never found that it makes any improvement. It may well be that the slightly serrated edge left by the grinder makes it easier for the tool to slice through the fibres of the wood.

There are occasions when a slip stone should be used. When a gouge is sharpened on the grinding wheel a burr is often left on the top of the edge, ie in the flute. This can prevent the tool from cutting properly; the burr can be taken off with a few strokes of a suitable slip stone.

In thinking about honing account should be taken of the fact that turning is a power assisted process. Consequently, the requirements are not the same as for woodcarving, for instance. The woodcarver has only his own muscles to apply and the work is often very delicate. He does find that honing leads to more satisfactory results.

Let us assume, for the sake of argument, that honing a turning tool can provide a sharper edge. The question is: how long will a very fine edge last when applied to hardwoods rotating at relatively high speeds? The friction and the heat generated in this process can destroy a very fine edge in no time at all. It may be thought that going to the grinder every time a tool needs sharpening will lead to tools being worn away very quickly. In practice this is not a great problem. Once the turner becomes proficient in grinding all that is required is just a short, light, touch on the wheel.

4.7 Safety

Potentially, a grinder is a very dangerous machine. However, if it used with due consideration safety should not be a problem. The need to take care when a new wheel is fitted has already been mentioned. The other principal danger, when the wheel is in use, is that particles of metal can be thrown off with sufficient force to penetrate the eyeball. As a consequence eye protection should always be used: either safety glasses or a full face mask should be worn. Similar care should also be taken when dressing a wheel.

It should be recognised that a grinder will go on revolving long after it has been switched off whilst being relatively quiet. It remains dangerous in this state not only to the operator but also to anybody else, particularly a child, who might come into the workshop and unintentionally put their hand on the machine.

Chapter 5: Safety

5.1 Introduction

We are getting near the point when we can put a piece of wood in the lathe, switch on and start practising. But before we do that there are a number of important points regarding safety which need to be considered. It should be noted, however, that serious accidents from woodturning activities are relatively rare. Nonetheless, very few human activities are completely risk free and it is sensible to obtain as complete an understanding as possible of where possible dangers may lie in woodturning. What we need to be concerned with principally are those accidents which can cause serious hurt or disablement. In the following I will look at those areas where there is potential danger.

5.2 Clothing

The danger with clothing lies in the possibility that it might be caught in the lathe or the work-piece as it revolves. As a consequence all clothing should be relatively tight fitting. Ties should not be worn, and there should be no loose cuffs, or anything of a similar nature, which might get caught up. Unless watches are covered by clothing they should be removed, as should rings, necklaces and other items of jewellery. There is also the possibility of injury to the feet. Since I dropped a large bowl blank on my toes I have thought it a good idea to wear safety shoes. Sandals and even trainers are inadvisable.

5.3 Hair

Long hair should be kept carefully under control when near any machinery. I have never heard of it happening to a woodturner but in engineering workshops people have been scalped because their hair has been caught in machinery.

5.4 Eyes

Some sort of protection for the eyes is desirable, at the very least safety glasses should be worn. As I normally wear glasses with plastic lenses I tend to rely on these under most circumstance. However, if, when turning, I think there is particular danger of a loose piece of wood or bark flying off I put on a full face mask. As an extra precaution I also stand out of the firing line. Eye protection is also very necessary when using the grinder. There is always a possibility that a fragment of metal or other debris may be flung off the wheel. This is particularly likely when dressing the wheel.

5.5 Wood dust and toxicity

Wood dust, particularly fine dust, is an almost invisible but insidious hazard. Long-term exposure to wood dust can have effects on the eyes, nose, throat, lungs and skin. Effects on the eyes include: soreness, watering and conjunctivitis. Those on the nose include: rhinitis (runny nose), violent sneezing, blockage and (very rarely) nasal cancer. The effects on the lungs include: breathing difficulties, impairment of lung function and the triggering of asthma attacks. There have been instances where the inhalation of wood dust has had whole body effects such as headache, thirst, nausea, visual disturbance, drowsiness, anaemia and hepatitis.

The long-term effects are likely to concern only professional turners who have been working at the craft for a relatively long period. Nevertheless, some of the effects described above, such as sneezing, can occur after short-term exposure. I

have suffered from a sore throat and cold-like symptoms after a few days in the dusty conditions of a woodworking exhibition.

Relatively short exposure to wood dust, such as that which may be experienced by amateur turners, can also have irritant effects on the skin which can lead to nettle rashes or irritant dermatitis. Symptoms usually only persist as long as the affected skin site remains in contact with the dust. Similar, and more worrying effects, can result from the development of allergic dermatitis caused by contact with the dust of specific wood species. Asthma can also be caused as a similar specific allergic reaction. Once sensitised the skin or lungs may react severely if subsequently exposed even to very small amounts of dust from the specific species.

As far as woodturning is concerned wood dust is mostly produced by sanding, particularly power sanding, on the lathe, as well as by cutting wood on the band-saw. Dust is also raised by sweeping and cleaning-up. Any turner who wears glasses will know that when these operations are taking place the lenses quickly become covered in dust. This is what one is breathing unless precautions are taken.

The most dangerous dust is the finest dust. This fine dust is so light it will hang in the air for a long period after the activity which produced it has ceased. Ideally an efficient dust extraction system which will remove the smallest particles should be fitted. But many amateurs, and those who spend only a limited amount of time turning, will be not be able to justify such expense. In that case some form of dust mask, or a battery powered respirator, should be worn.

Protection against allergic reactions to wood dust is very difficult to achieve. Fortunately, for most of us, it is relatively uncommon. Those of us who have not suffered in this way should not be smug, however, because an allergy can strike without warning and once sensitised the victim will always remain allergic. There is a mitigating factor in that these allergies, as mentioned above, are specific to particular species. The answer for those who have become allergic to a species is to try to avoid using it.

Another possible danger from dust is that of fire or explosion. Explosions caused by wood dust are not unknown but I have never heard of them occurring in a woodturner's work-shop. Where the latter is concerned, one place where high enough concentrations of dust might occur is within a dust extraction system, particularly if there are positions where dust might collect.

Fine dust gets everywhere in a work-shop including electrical fittings such as plugs and switches. It is conceivable that a spark might ignite such dust when it could smoulder for some time before bursting into flame. Fire and explosion from such causes are unlikely perhaps, but it is well to be aware of the possibility.

5.6 Noise

Noise can also create a long-term hazard. Persistent exposure to loud noise can result in deafness. Generally speaking, woodturning is not a noisy occupation, but there can be occasions when it and allied activities such as powered sawing, particularly with a chain-saw, can produce high sound levels. On such occasions it is a wise precaution to wear ear protection.

5.7 Physical fitness

There are some books on woodturning that advise one never to work when tired. This really is a counsel of perfection. Only in an ideal world would it be possible to follow that advice. The use of alcohol is another matter. Using any machinery after drinking should be avoided.

5.8 Guards

Guards, particularly those over pulleys on the lathe and on band-saws, are fitted not only to protect the operator from an absent minded action, or slip, but also to protect other people who may come into the work shop. They should be used.

Lathes are sometimes used in public places, such as craft fairs, where guards and safety screens are even more important. I have seen a lathe at a craft fair used with no guards over the pulleys and nothing to keep the public at a safe distance. That is irresponsible. I have also seen a turner at a craft fair wearing a face screen to protect himself but with no safety screen to protect the public. In such circumstances clear polycarbonate plastic safety screens should be fitted. Polycarbonate is very strong, in contrast acrylic is unsuitable because it can shatter under impact.

5.9 Turning speeds

If the turner is in any doubt about which speed to use the lower option should always be selected first. The danger from excessive speed is that the work-piece, or bits of it, may be flung from the lathe. The biggest danger is from a work-piece that is badly split or is built up from glued up pieces (such as stave work). I once had an extremely painful blow on the arm from a large oak platter which split into two pieces as I was taking a cut. I was lucky - a piece might have hit me in the face or some other vulnerable area. I have also heard more than one story about the disintegration of built-up work. Where any danger of such mishaps is perceived a low speed should be selected.

Quite frequently pieces of scrap wood are glued to the work-piece as a means of mounting it on a face plate, or chuck, to prevent screw marks appearing in the finished piece. It is tempting to use plywood or MDF (medium density fibreboard) for this purpose. This should be avoided if the work-piece is of any size. Both of these materials tend to be very weak across the layers and may split under load. The use of paper in the glue joint is often recommended for the reason that it makes it easier to separate the waste piece from the finished work. For that very reason this technique should be used only be on relatively small jobs.

5.10 Checking the work-piece

When starting a new piece of spindle turning care should be taken to ensure that the work-piece is held firmly. Subsequently, the work-piece should be checked from time to time to make sure that it has not worked loose.

5.11 Adjustment of the tool rest

Whenever a new work-piece is fitted to the lathe it should be rotated by hand before switching on to ensure that any projections will not catch on the tool rest. Whenever adjustments are to be made to the tool rest the lathe should be switched off. Before switching the lathe back on the work-piece should again be rotated by hand.

5.12 Polishing

A possible source of danger to the hands is the use of cloth for polishing. When a piece of rag is used, particularly a piece with loose strands where it has been torn, it can get caught in the rough wood where the work-piece has been partially parted off. When this happens the cloth is wrapped tightly around the wood in a fraction of a second. Consequently, when cloth is used, it should be held loosely in the hand so that if it is caught it will pull out easily. It should definitely not be wrapped around the hand. It is best not to use cloth at all, many turners now use paper towel for

applying finish and polishing. It is readily available, cheap and, above all, safe. If it does catch on the wood it just tears.

5.13 Precautions against a dig-in

Fear, and the muscular tension which accompanies it, can inhibit the novice turner. If the beginner is very afraid of a dig-in, and what happens as a consequence, he can make arrangements for the drive to slip (like a clutch) if unusual resistance is encountered. On some lathes it is possible to run the lathe with a loose belt. Where this is not possible the work-piece can be driven with a solid cone centre or ring centre. In this case a rotating centre must be used at the tailstock end. Either of these arrangements will permit the drive to slip if there is extra resistance.

5.14 Use of the correct tools

It should become clear from the instructions which follow in subsequent sections of this book that successful turning will only result from the use of the right tools for the job. The use of the wrong tools, or the right tools in the wrong way, can also be dangerous. The instructions given should be followed with care.

5.15 The use of other machinery

This is not the place to comment on the safe use of all the additional machinery which might be used by the wood turner. There are, however, three machines which can be considered, two of which are very commonly used, ie the grinder and the band-saw, and one which is used from time to time which is potentially extremely dangerous. The main safety precautions to be taken in relation to the grinder are covered in Chapter 4 and should be referred to there.

I am not qualified to comment on all the safety precautions which should be taken with a band-saw. Nonetheless, there are a number of things I have become aware of through experience. Full use should be made of the safety guard. This should always be brought down as close to the work as possible. Like a grinder the a band-saw will continue to run after it has been switched off. Consequently, after completing a cut I make a practice of pulling the guard down to table level. Obviously the fingers should be kept as far away from the blade as possible, push sticks are a must.

It is often necessary to cut pieces of wood of an irregular shape. These can include burrs and limb wood. Because of lack of support under the blade the work can be caught by the teeth and given a sudden, uncontrollable, jerk. As a result the fingers could be brought into contact with the blade. Even if this does not happen the fingers can be injured by being caught under the work - I once lost a finger nail when this happened when I was attempting to cut a small log. Some means of safely supporting such pieces of work should be found.

The tool to be treated with the utmost respect is the chain saw. This is not the place to go into the safe use of this tool. Anyone preparing to use this tool should ensure that they are aware of all the hazards it presents, and that they make use of the appropriate safety measures and clothing.

5.16 A clear floor space

Wherever there is machinery there is the danger that someone will trip up and put their hand on moving parts. Because of this the floor of a work shop should always be kept clear.

5.17 Fire

Fires do occur in work-shops. They may not be a source of personal danger but they are a hazard which could result in damage to property and equipment. Particularly in timber work shops naked lights and inflammable materials should be handled with care. An eye should also be kept open for the possibility of electrical faults. Cloth or paper soaked in finishing materials such as cellulose or oil can ignite by means of spontaneous combustion if collected together in sufficient concentration. I make sure that each piece has thoroughly dried out before binning it.

5.18 Conclusion

This chapter turned out to be much longer than I expected when I began writing it. But I make no apology for labouring the point. Serious accidents to woodturners are uncommon and are no more likely to occur than accidents to people undertaking other relatively 'safe' activities. I used to know two people who had accidents playing table tennis; one broke his jaw and the other his ankle. If we were deterred from such activities because of the fear of an accident then we would not do anything and miss a lot of pleasure. Having said that, it should be acknowledged that the possibility of an accident can be greatly reduced by knowing where the dangers may lie. My two table tennis playing friends could have avoided some serious discomfiture if one had been aware of the danger of slipping on water on the floor and the other of a brick lying in the corner of the room.

Please note: much of the information in Section 5.5 (Wood dust and toxicity) has been drawn from the Health and Safety Executive sheet on Toxic Woods.

Part Two

Some Important Theoretical Points

Chapter 6: Making the cut

6.1 General introduction

This chapter, and the one which follows, deals with the general way in which the turning tool is controlled so as to produce a good clean cut. This should leave the wood with a smooth surface unmarred by torn fibres. In later chapters instructions will be given on how to perform the specific operations by which the range of basic shapes, which form the fundamentals of woodturning, are produced. A description of these basic forms (or cuts) is given in Chapter 8. This present chapter is concerned with the factors which are common to all these operations.

In considering these factors we will start with the position of the body and end with thoughts on the direction of the cut in relation to the grain of the wood in the following progression:

- the position of the body (the stance)
- the way the tool is held in the hands (the grip)
- the attitude of the tool (the rubbing bevel)
- the way the correct attitude of the tool is maintained
- the direction of the cut in relation to the grain.

This analysis will focus on the use of cutting tools, eg chisels and gouges. Some thought will be given to the use of scrapers in a later chapter

6.2 The correct stance

When first learning to turn it is vital to adopt the correct stance. There are two main reasons for this. One is that the turner will be standing at the lathe for long periods - the adoption of the correct stance will help to reduce the fatigue that this entails. The other, with which we are particularly concerned here, is that much of the control of the turning tools comes not only from the hands but also from body movements. Often, when making a cut, the body and the hands should move as one. It will be found from experience that it is much easier to maintain the tool in the correct attitude if the body forms a firm platform for the hands.

Initially, when the turner is preparing to make a cut on a work piece held between centres, the body should be balanced on both feet with the legs and trunk more or less vertical without any twist. If the top half of the body is bent over very far then it will not be long before backache sets in. The position of the feet is important; they need to be close to the lathe so that the turner can reach the rest without bending very much. The position of the feet also determines the orientation of the body in relation to the axis of the lathe. A slightly oblique position is suggested; that is to say a line drawn through the shoulders should cut the axis of the lathe at an angle of somewhere around 15 degrees. So the feet need to be a little distance apart and pointing in the correct direction (see Diagram 6.1).

The stance should also be compact with the elbows kept close to the sides of the body. Because of this the right hand (of a right handed person) should be positioned to hold the tool just below the ferrule. Tool handles are usually made considerably longer than required for many operations. When the right hand is held too far back the elbow is pushed away from the body, ie behind and to the side. If this happens there is little to stop it wobbling around out of control and the necessary movements of the wrist and fingers are seriously inhibited. The forearm should be kept in line with the tool so that the fingers, and the wrist, can easily rotate the tool around its axis.

In carrying out a cut movement must take place. But, as far as is practical, the

movement should be confined to the body rather than the hands or arms. In carrying out the planing cut, for example (see Chapter 11) the tool is traversed along the work piece by means of a sideways movement of the complete body.

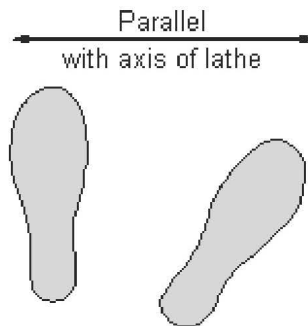

Diagram 6.1 The position of the feet

Let's take a detailed look at the situation of a right-handed person making such a cut from right to left. The feet are positioned so that the body is in the oblique position with the right side furthest from the lathe. At the commencement of the cut the weight of the body is shifted onto the right foot with the body leaning slightly to the right. As the cut is made, and the tool is moved along the wood, the weight of the body is transferred from the right foot onto the left so that the body is leaning in that direction. Whilst this action is being carried out the body should not be allowed to twist and the upper arms should maintain a constant position in relation to the trunk. The movement of the lower arms and the hands should be limited to the extent of keeping the tool in the necessary attitude.

It must be emphasised that the above description is only meant to give an approximate indication of the required stance and accompanying movement. Each turner should take up a stance which he finds comfortable. This description has been applied to turning between centres but the general idea behind it also applies to end grain and bowl turning - that is to say, in these activities as well the body must do as much of the work as possible. Generally speaking the stance should also be compact but bowl gouges have long handles and the turner may stand somewhat further away from the lathe. Then the right hand, holding the end of the handle, may be allowed to rest on the body somewhere in the region of the hip.

6.3 The grip

This leads to the question of the grip. In the case of the left hand there are two basic ways of holding the tool: the overhand grip and the underhand grip. I tend to alternate between one and the other according to circumstances. It is difficult to specify what these circumstances are but they are not critical. The novice should experiment to see which seems to be the most comfortable in various situations.

With the overhand grip the hand is on top of the tool and normally all the fingers are wrapped around the blade with the thumb underneath and the palm facing downwards. With the underhand method there are two possible grips. One is similar to the overhand grip but with the hand underneath and the palm facing upwards. In the other, which is used when more sensitivity and control is required, the hand is positioned underneath but the blade is held just by tip of the forefinger and the thumb. As the tool is manoeuvred the tips of some of the other fingers may come into play.

In the case of the right hand there is a similar choice between the palm grip, where the fingers are wrapped around the handle and the palm is in contact with it, and the finger grip, where the handle is held between the tips of the fingers and the tip of the thumb. The finger grip is mostly used on spindle work when sensitivity and control are required for the more delicate work, such as cutting a small bead. This grip is difficult to master and the novice is advised to use the palm grip.

6.4 Controlling the cut

Having looked at the stance and the way the tool is gripped we now need to look at the position in which the tool should be held so as to produce a clean cut. Wood cuts best when the fibres are severed cleanly and not ripped out of the wood. This is achieved by keeping the bevel of a sharp cutting tool in contact with the wood, i.e. keeping the bevel rubbing in short. As will be shown later it is important to cut with the grain as much as possible.

How is the contact between the wood and the bevel maintained? Diagram 6.2 shows a properly ground tool with the underside of the bevel correctly positioned, flat on the wood. In this position the bevel is said to be 'rubbing'. As shown in the diagram there are two forces acting on the tip of the tool. Force A represents the resistance of the wood to be cut which has the effect of pushing down the cutting edge into the wood. Force B represents the resistance of the wood to the flat of the bevel.

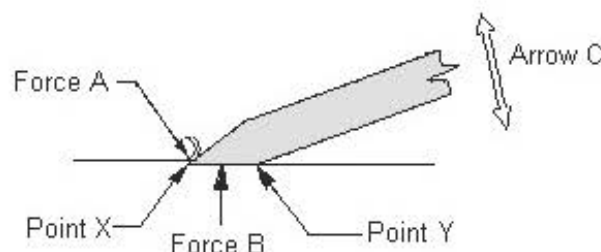

Diagram 6.2 The tool in the correct cutting position

In many circumstances, if the tool is maintained in the attitude shown, force B and the downward component of force A and will be virtually equal and the tool will cut smoothly with the turner having to do little other than push the tool along. It is often possible for an experienced turner to make a cut using only one hand (on the handle). At other times, however, because of the uneven consistency of the wood, the tool may have a tendency to bounce. In this case the turner may have to apply some downward force in order to keep the bevel in contact with the wood.

How is the correct attitude of the tool maintained? Let us think first of all about the situation faced by a woodcarver who is pushing the tool along with his hands. It can be seen from Diagram 6.2 that if the tip of the handle is moved down in the direction of arrow C the tool will pivot about point Y (the heel of the bevel), the cutting edge will lift, and the depth of cut will be reduced. If, on the other hand the handle is raised, point Y will lift off and the cutting edge will go deeper into the wood, so taking a bigger cut. If this process is not terminated the edge will continue to bury itself in the wood. In order to regain the control the carver will have to lower his hands until point A is again in contact with the wood and the bevel is rubbing. In moving his hands up and down to control the depth of cut the carver is in effect using the heel of the bevel as a fulcrum.

The situation is very much the same for the turner except that he has to use the tool rest to help him to control the tool. Because of this control is exerted not just by raising or lowering the handle but also by making small adjustments to the amount of the tool extending over the tool rest. The latter adjustments are very subtle and tend to be performed automatically by the experienced turner. The way to gain this skill is not to think about the position of the tool in relation to the tool rest but, instead, to focus attention on the use of the bevel.

6.5 Problems caused by a badly sharpened tool

On all cutting tools the bevel must either be flat or concave (ie hollow ground); it must never be convex. Two of the problems created by rounding off the bevel of a tool when sharpening are illustrated in Part A in Diagram 6.3. One is that the effective bevel angle is greatly increased, so reducing the efficiency of the tool; the other is that there is a very good chance that when the major part of the bevel is rubbing the tool will not cut at all. Part B of this diagram shows that in order to get the tool to cut the heel of the bevel will have to be lifted well clear of the surface. In this position the cutting edge has very little support from the bevel and is likely to force its way into the wood, producing a 'dig in'. Clearly, unless the bevel of the tool is either flat or hollow ground the tool will be difficult to control.

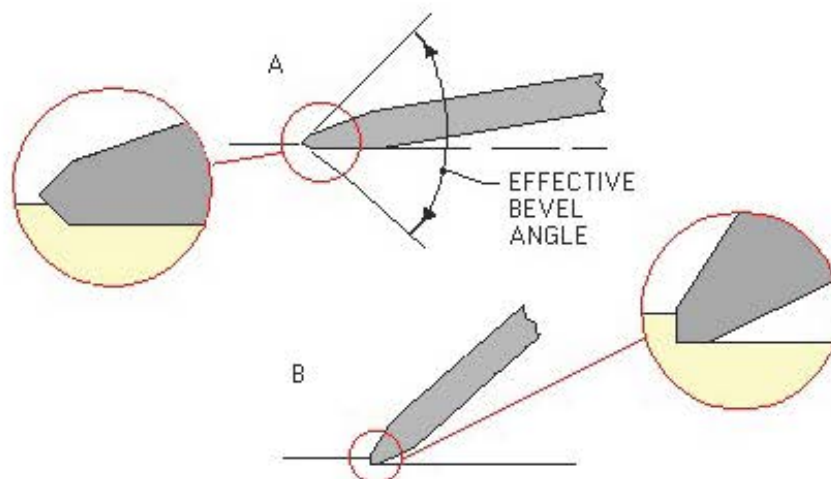

Diagram 6.3 A badly sharpened tool

6.6 The concept of the rubbing bevel

In the foregoing I have referred to the need to keep the bevel flat (ie, rubbing) on the wood. For convenience it has also been assumed that the wood is flat. On a flat section of wood either the whole of the bevel must rub or none of it. But on a curved piece of wood (and most surfaces of a piece of turnery are curved) it would seem to be impossible for the whole of the bevel to rub. On an inside curve, e.g. on the inside of a bowl, there will be contact at two points, on the cutting edge and on the heel. In theory, on an outside curve only a small part of the bevel, that adjacent to the cutting edge, can be in contact with the wood. Nevertheless, it can be argued that the concept of the rubbing bevel is one of the most important in the woodturning process.

Some years ago there was a debate in one of the woodworking magazines (in the UK) between two experienced turners; one of them insisted that the bevel must rub all of the time the other disagreed strongly.

The crux of this argument depends, not surprisingly, on what is meant by the bevel: is it the whole of the bevel or only a small portion of it? On an inside curve the two points referred to above, ie the edge and the heel, should be in contact. On an outside curve the bevel should lie on the tangent to the surface at the point being cut (see Diagram 6.4). In such a case the bevel is providing less assistance to the control of the cut.

As a consequence it is easy for the beginner to lapse into a scraping action, particularly with the roughing gouge. For this reason, when spindle turning it is often found beneficial to hold the cutting edge of the tool at an angle to the axis of the lathe whilst moving the tool in the direction in which it is pointing (see Section 10.3). This has the effect of flattening the curvature of the wood; as consequence the bevel has more support.

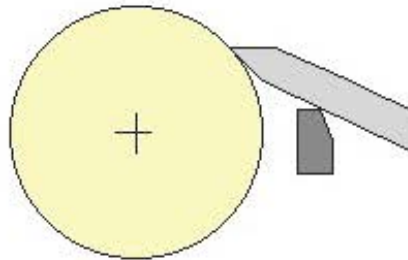

Diagram 6.4 The bevel rubbing on an outside curve

There is, however, a practical aspect of this which needs to be considered. This is that the wood is often soft enough to deform slightly under the force of the cut. As a consequence if the curvature of the wood is not too great the bevel is pressed into the wood, so making greater contact. The effect of this can often be seen in the way the wood is burnished smooth. Sometimes the smooth finish will be slightly marred by scratches made by the heel of the bevel where it has been pressed into the wood. This is proof (if any is required) that the bevel has been rubbing along all of its length.

Some qualification of the term 'rubbing' is required - what it really means is keeping the bevel flat on the wood. It does not mean that it should always be pressed down hard on the wood. Sometimes it is necessary for the bevel to just brush the wood.

Chapter 7: The effect of grain and other factors on the cut

7.1 Introduction

In the previous chapter, in thinking about the way the tool cuts, three important factors were temporarily ignored. These are :

- the question of grain and its direction
- the rotation of the work-piece
- the fact that the cutting edge is often held at an angle to the direction in which the wood is moving (the slicing cut)

7.2 The concept of grain

The cells of the wood, which take the form of hollow cylinders, join together to form strands of fibres which lie in a uniform direction which is more or less axial either to the trunk or to its offshoots. The lay of the fibres is commonly referred to as the 'grain'.

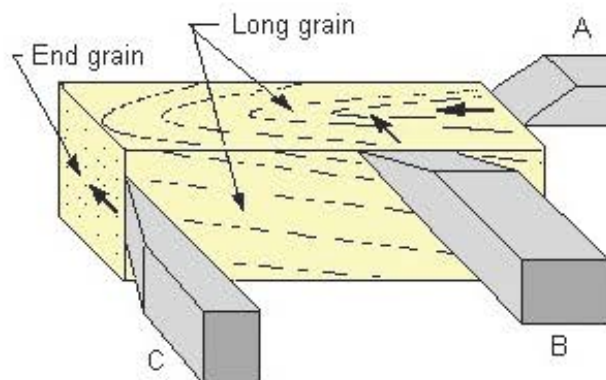

Diagram 7.1 Primary forms of cut

Diagram 7.1 shows a block of wood in which the grain is running longitudinally. Three tools are shown as if about to make cuts in the directions indicated by the arrows. These illustrate the three primary forms of cut; as defined in the common expressions of:

- cutting along the grain (A);
- cutting across the grain (B);
- cutting end grain (C).

In practice of course, particularly in woodturning, there is an infinite range of variations on these cuts. Not only can any number of intermediate positions between those shown be taken up but the edge of the tool does not necessarily have to be held at 90 degrees to the direction in which the wood is moving.

It should be noted that in Diagram 7.1 the wood is assumed to be stationary and the tool to be moving. Often, in woodturning both the wood and the tool are moving, but with the wood moving faster than the tool. For the purposes of analysis, in this particular context, this does not matter; all that we are concerned with here is the movement of the wood and the cutting edge in relation to each other.

7.3 Cutting along the grain

Anybody who has worked wood with a hand plane will know that it is desirable to plane with the grain. Diagram 7.2 illustrates the common situation in which the fibres of the wood lie at an angle to the edges of the wood block.

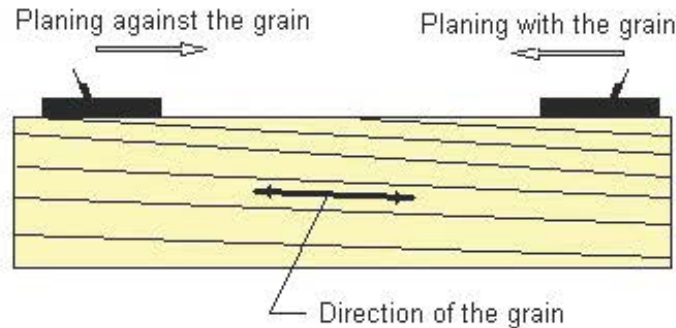

Diagram 7.2 Planing with and against the grain

When the wood is planed with the grain any splitting between the fibres takes place above and in front of the cutting edge, which subsequently severs the fibres neatly, so leaving a clean surface, as shown in Diagram 7.3.

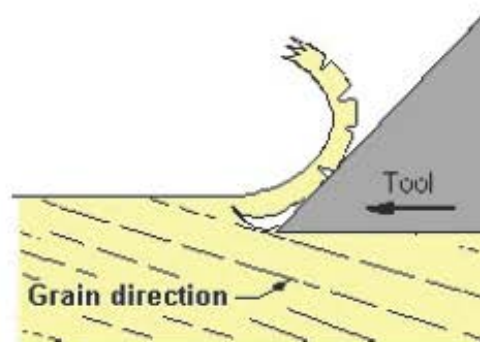

Diagram 7.3 Cutting with the grain

Based on: Bruce Hoadley. (1980) Understanding Wood. Taunton Press

If an attempt is made to plane against the grain the cutting edge picks up the ends of the fibres, lifting them out of the wood, so that they break off in an irregular manner leaving a rough finish. This is illustrated in Diagram 7.4.

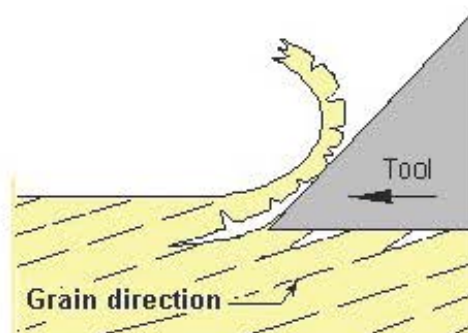

Diagram 7.4 Cutting against the grain

Based on: Bruce Hoadley. (1980) Understanding Wood. Taunton Press

7.4 Cutting end grain

When an attempt is made to cut end grain the cutting edge is forced across the ends of the fibres and there is a danger that they will be disturbed below the cut surface before they are severed (see Diagram 7.5). If the tool is allowed to pass beyond the edge of the work-piece, where the fibres have no support, a piece of wood may splinter off. When cutting end grain fine cuts need to be taken to minimise this problem.

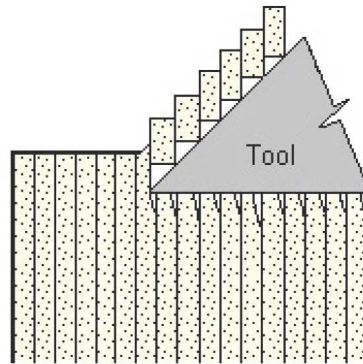

Diagram 7.5 Cutting end grain

Based on: Bruce Hoadley. (1980) Understanding Wood. Taunton Press

7.5 Cutting across the grain

When cutting across the grain the wood fibres will lie parallel to the edge of the tool. As the tool penetrates the wood the fibres do not always separate cleanly in front of the edge of the tool (as illustrated in Diagram 7.6). Some of the fibres may be lifted out of the surface below the cutting edge leaving a series of parallel furrows. This affect can often be easy to see; one instance is when a parting tool has been used to cut a groove.

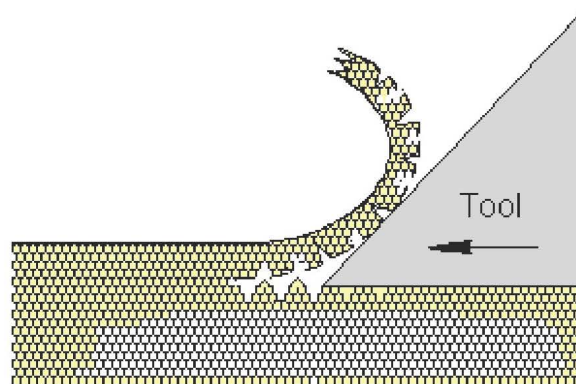

Diagram 7.6 Cutting across the grain

7.6 The way the work is held on the lathe and the terminology

The different ways in which the work piece can be held on the lathe affect the way the grain runs and have important implications for the way in which the wood is cut.

There are three main ways of holding the work-piece in the lathe:

- between a drive spur in the headstock and a centre in the tailstock
- by one end only
- by one face only

The first of these two is commonly referred to as turning 'between centres'. The term 'spindle turning' also refers to 'between centres' work but usually in relation to a relatively slender work-piece such as a chair leg or a lamp column. Generally, however, these terms are interchangeable. It should be noted that the techniques used in spindle turning can, and frequently are, applied to a work-piece held by one end only. The stem of a goblet is a good example.

Bowl turning is usually carried out with the work piece held on one side only; nevertheless it is possible for some, if not all, of the operations to be carried out with the bowl-blank held between centres. Also, although bowls are usually made from a work-piece in which the grain is orientated at right angles to the axis of the lathe they can also be made from a piece in which the grain runs parallel to the axis. We need to use some terminology which will cover all the combinations which these possibilities allow.

When the inside of a bowl, a goblet, or any similar object, is hollowed out with the work-piece held by one end, or one side, and with the grain parallel to the axis of the lathe, this is commonly referred to as 'end grain turning'. As far as I am aware there is no common term applied to the same operation carried out where the grain is at right angles to the axis (ie on a 'normal' bowl). The term I apply to this is 'face turning'. If any of the operations on a bowl are carried out between centres then these would be described by that term, that is as work carried out 'between centres'.

7.7 The implications of rotation

If we look at a cylindrical work-piece held between centres in the lathe we may see the grain running through it at an angle as shown in the piece of wood illustrated in Diagram 7.2. Then if we rotate the work-piece half-a-turn (ie 180 degrees) the grain will, in effect, be running in the opposite direction. Thus, when turning a cylinder, the grain, as it is encountered by the cutting edge of the tool will continually be changing its direction. Whether the tool is moved from left to right, or from right to left, the cut will alternately be made with and against the grain.

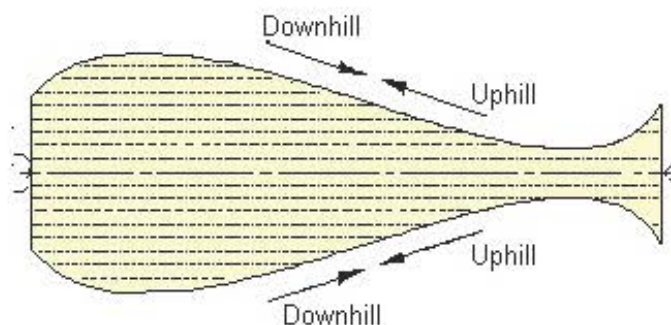

Diagram 7.7 Uphill and down hill - between centres

As soon as any shaping of the work piece takes place, however, the situation changes. Consider the vase shape shown in Diagram 7.7; for convenience, in this

case, it is assumed that the grain is running parallel to the axis of the lathe. Cuts made in the direction marked 'downhill' will invariably be made with the grain and those marked 'uphill' against the grain. The terms 'uphill' and 'downhill' have been used because they have become part of the woodturner's vocabulary. In this context, however, the terms 'up' and 'down' do not necessarily refer to tool movements related to the centre of the earth but to their relation to the work-piece. Thus a cut made downhill, ie with the grain, on a spindle turning is one made towards the central axis of the turning.

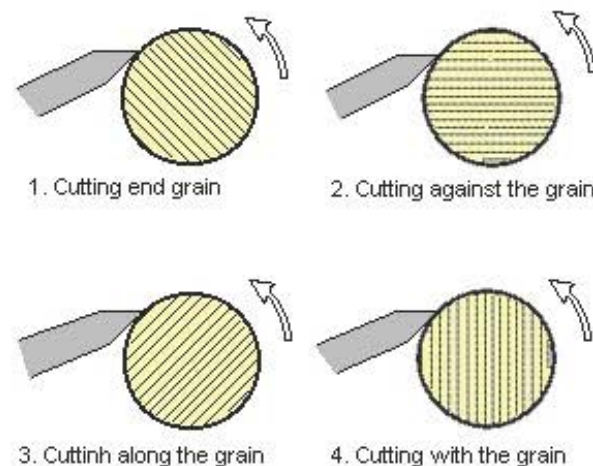

Diagram 7.8 Cutting on the side of a bowl blank

When a face turning, such as a bowl is considered the situation changes. This is illustrated in Diagram 7.8, where the grain is assumed to run at a right angle to the axis of the lathe. The arrows show that when a cut is made on the side of a disk the grain direction is continually changing, eg (1) end grain, (2) against the grain, (3) along the grain, (4) with the grain.

When the bowl shape is being formed the question of uphill or down re-emerges as shown in Diagram 7.9. Whether a cut is made uphill (against the grain) or downhill (with the grain) depends on the direction of the slope of the surface on which it is made (in relation to the axis of the lathe) and whether it is made on an inside or outside curve.

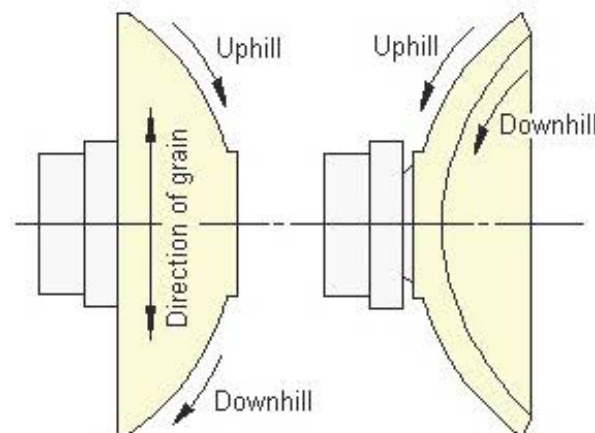

Diagram 7.9 Uphill and downhill - shaping a bowl

Similar consideration apply to an end grain turning, such as a goblet. A cut made towards the axis on the inside of the cup will be uphill, ie against the grain. A cut made on the outside of the cup, also towards the axis will be downhill, ie with the grain.

At some point, when a bowl with a well rounded shape is being turned, the effects shown in Diagram 7.9 may be outweighed by those shown in Diagram 7.8, and when the gouge is encountering end grain it may begin to pick up the fibres of the wood. Even for experienced bowl turners this can create a problem. We will look at some methods which can be used to minimise the tearing of end grain on bowls when bowl turning is considered in detail in a later chapter.

7.8 The slicing cut

Diagram 7.10 shows a work-piece held between centres with the grain running parallel to the axis of the lathe. Two square nosed chisels, A and B, are shown positioned with their bevels in the rubbing position. It is convenient, but not important, to assume the chisels to be square nosed, but B could, in fact, be skewed. What is important is that it is assumed that the edge of chisel A is held parallel to the axis whereas that of B is held at an angle. Unless chisel A is narrow, like a parting tool, it will be very difficult, if not dangerous, to hold in that position. The reason for this is that not only will the cutting edge be in contact with the wood along its full length, it will also be parallel to the fibres of the wood; ie it will be cutting across the grain. Since both ends of the edge will be below the surface of the wood the fibres will have to be torn away at these extremities. Even if the cut can be maintained the surface left will tend to be very rough.

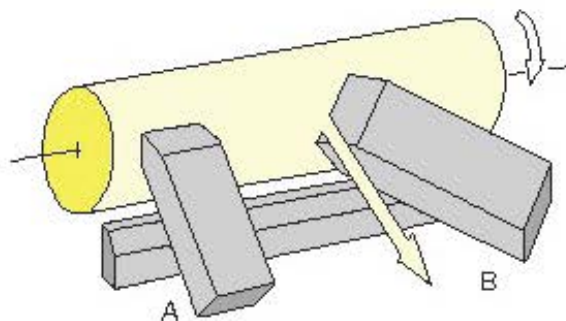

Diagram 7.10 The slicing cut

The case of chisel B is very different. Because it is held obliquely to a curved surface only a small portion of its edge is in contact with the wood; as a consequence it will take a relatively narrow shaving. It should also be noted that the fibres at the edges of the shaving are severed by the tool.

There is yet another factor to be considered. The direction in which the shaving is travelling is shown by the arrow in Diagram 7.10 B. It can be seen that the edge of the tool is at an oblique angle to the direction in which the shaving is travelling. This means that the wood fibres are moving along the cutting edge so producing a slicing cut. The fibres are very fine and if they and the edge of a sharp tool were greatly magnified (on a similar scale), the tool would be seen to have a jagged edge like that of a saw. The saw-like action severs the fibres still more cleanly.

In the instances I have been looking at in the above paragraphs the chisel has been positioned so that it has been cutting along the grain (ie parallel to the grain). It should be noted, however, that the slicing effect is enhanced when the cutting

direction is downhill, ie when the cut is being made with the grain. When a slicing cut is combined with cutting with the grain the possibility of lifting the fibres out of the surface below the cutting edge is considerably reduced and very clean cuts are possible even on awkward material.

It should also be noted that cuts in which the edge of the tool is oblique to the direction in which the wood is moving, ie slicing cuts, can also be made with gouges in which ever circumstances they made be used, eg when cutting a cove or forming a bowl.

Part Three

Spindle Turning

Chapter 8: Introduction to spindle turning

8.1 The basic cuts

When I am teaching students on my courses I always teach spindle turning before end grain or bowl turning. The reason for this is that it provides a pattern of learning in which the student proceeds in a short series of simple, easy to understand, steps. These steps pretty well programme themselves and provide a structured introduction to the discipline of woodturning. When they come to bowl turning students can then be shown how to adapt the principles they have learned to the new form.

There are only a small number of basic cuts used in spindle turning. Once the turner has learnt to perform these correctly he can, in principle, turn anything between centres. Assuming that we are starting with a square blank these cuts are as follows:

- Roughing down to a cylinder
- The smoothing/or planing cut
- ‘V’ cuts
- Forming a Bead
- Forming a cove
- Blending beads and coves
- Squaring the end
- Rounding the end
- Cutting pummels

Let us look at these cuts in sequence so that the reader knows where he is going.

8.2 Roughing down

The first job to be done when undertaking a piece of spindle turning is to ‘rough’ down the square blank to a cylinder. This is done with a large gouge normally used only for this particular operation. Not surprisingly it is called a ‘roughing out gouge’ (or roughing gouge). The operation gets its name from the fact that the gouge leaves a rough surface; it can also be a fairly crude and brutal operation. For a professional, for example, it is a job which needs to be done as quickly as possible so that the interesting work can start.

8.3 The planing cut

The planing cut is analogous to the use of the smoothing plane in general woodwork. It is done with a chisel immediately after roughing down. The skew chisel is used to produce a good surface which should require little sanding.

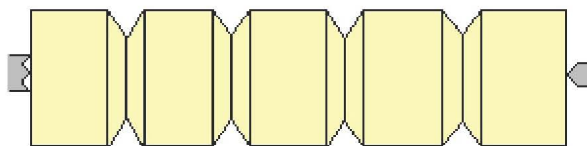

Diagram 8.1 ‘V’ cuts

8.4 The ‘V’ cut

As the reader will anticipate the ‘V’ cut is used to make a ‘v’ shaped depression in the work piece (see Diagram 8.1). Such a cut may be made for its own sake, as

part of the decoration of the work piece; but often it is made as the first step in the cutting of a bead or similar operation.

8.5 The bead

A beading cut is used to form a bead - this a piece of decoration running round a piece of turning which is roughly semicircular in cross-section (see Diagram 8.2). It is upstanding like a hill.

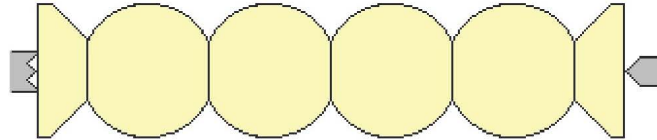

Diagram 8.2 Beads

8.6 The cove

A cove is the opposite of a bead. It is also roughly semicircular in cross-section but forms an indentation like a valley (see Diagram 8.3).

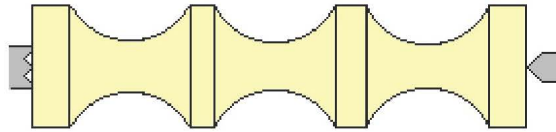

Diagram 8.3 Covs

8.7 Blending beads and covs

As suggested above the profile of a true bead or cove approximates to an arc of a circle, very often, but not always, approaching the full semicircle. They are often applied as a form of decoration. In other cases, however, the form of the the item being made will call for more gentle bumps or hollows. Often these will flow together. One example is the handle of a turning tool (see Diagram 8.4). Blending bumps and hollows together calls for an extension of the skills used for cutting beads and covs.

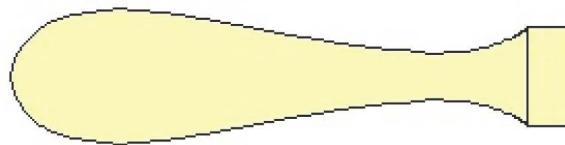

Diagram 8.4 Blending a bead and a cove to form a handle shape

8.8 Squaring the end

Sometimes it is necessary to cut the end of the work piece square with a perfectly clean cut, that is, one without any torn fibres. This cut is similar to that for a 'V' cut

but many turners find it rather more difficult.

8.9 Rounding the end

There are occasions when it is necessary to make the end of the work piece completely round. This is not dissimilar to cutting a large bead but it is useful to consider it as a separate exercise because there are some additional points which can be made.

8.10 The pommel

At times, when making items such as table or stool legs, it is necessary to leave sections of the work piece unturned and in the original square condition. This, therefore, requires making a transition from the square section to the round. The section which is left square is called a pommel (see Diagram 8.5)

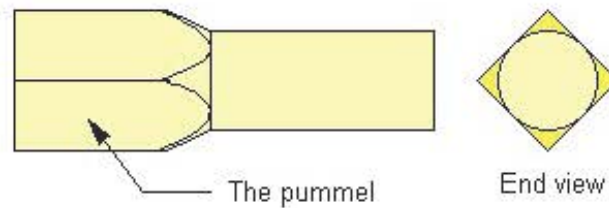

Diagram 8.5 The pommel.

Chapter 9: Spindle turning - setting up for practice

9.1 The blank

The most convenient timber to practise on is some kind of softwood. This has the advantage that it is cheap and readily available. The wood does not have to be of good quality. Old pallet wood, for example, will do nicely, and offcuts of floor joists can often be picked up on building sites. It is, however, best to avoid knots as much as possible because they are hard and create wild grain; as a consequence they are relatively difficult to turn.

Whatever wood is used, It should be cut to provide a blank about 2 in square by 12 ins long. Some turners, I believe, like to cut the corners off of a square to be used for spindle turning with a power saw or by planing. Normally, this is not necessary. Someone, I think it was Peter Child, said: "there is a machine designed to take the corners off, it's called a lathe".

9.2 Mounting the blank

Fit the practice piece between centres on the lathe. A two-prong or four-prong drive centre can be used at the headstock end. It does not greatly matter which, although I favour the two-prong. Alternatively, the suggestions I made in Chapter 5 (section 13) when referring to safety can be followed. If either a four prong or a ring centre is used to drive the work care should be taken to ensure that the end is cut square so that the points or the ring will be in full contact with the wood. If a cone point, or a ring centre, is used then it will be necessary to use a revolving centre in the tailstock.

If a spur drive is used a fixed centre can be used in the tailstock but, if so, a blob of light oil must be dropped on the work-piece where the point will penetrate. This relieves the friction and prevents burning of the wood. Care must be taken to tighten it up from time to time as the work progresses as it may become a little loose in the early stages. If this is not taken care of the work-piece could fly off the lathe and cause injury; in any case it needs to be held firmly if turning is to proceed satisfactorily.

9.3 The rest

Before the rest is fitted for the first time the top edge should be examined carefully to make sure it is smooth and free from paint, grooves or notches which might impede a tool which is slid along it. If it is not free from these defects it should be filed smooth. It should be remembered that a chisel or beading tool will probably have a relatively square corner which can catch quite easily. To allow chisels to slide more easily any sharp corners should be rounded off with a stone.

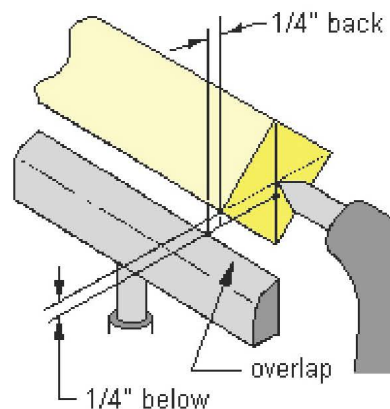

Diagram 9.1 The position of the rest for the initial exercise

Once the work-piece has been mounted the tool rest must be set in position. It should be placed where it will be about 1/4 in clear of the revolving corners of the work-piece and a little below its centre. It is not possible to be very specific about the latter distance. I am often asked how high the rest should be; my answer is “where it is comfortable”. The reason for this is that it depends on the height of the turner in relation to the height of the lathe. However, about 1/4 in should be about right to start with (see Diagram 9.1)

The point is that the rest should be in such a position that a cut can easily be taken whilst maintaining the recommended stance (see Chapter 6). This should not create any heartaches as the position is not that critical. After a couple of passes of the tool the beginner should begin to get the feel of where the rest should be.

In carrying out the exercises described below consideration should be given to the length of the rest. Ideally it should be about 8 ins long. Anything less than 6 ins will mean that it will have to be moved frequently. Anything more than 10 ins and it may become unwieldy and, if it is not strongly made, it may flex at the ends. But the beginner will probably have to use whatever rest is supplied with the lathe.

9.4 Turning speeds

It is also necessary to consider the selection of speeds. When I am demonstrating I am often asked what speed I am using. That is a reasonable question but it is one to which I do not necessarily know the answer. When I was using my Coronet Major all the time I would not think about speed as such but I would consider the size of the work-piece and then decide which of the five pulleys was appropriate. Occasionally, perhaps because the work-piece was a little out of balance, or for some other reason, I would decide that the speed was wrong and then move up or down a pulley. Now that I am using a lathe with an electronic variable speed I simply turn the control knob until I judge that the lathe is turning at a suitable speed.

So where does this leave the beginner. It should be noted that the “correct” speed is determined by a number of features of the work-piece, such as the diameter, the width or length, the weight, the hardness and density, and the fibre structure. To add to this there is the variability of turners’ techniques and the choice of tools and bevel angles. Even if there was such a thing as a “correct” speed, the actual choice is likely to be a compromise when there may be only three speeds available.

Please note, though, that even if it is not possible to choose the “correct” speed it is quite possible to choose the wrong speed. This is more likely to be too fast than too slow. I think it possible that many novices consider that high speeds (or the fastest practical speeds) are desirable. It is in fact much better (it is certainly safer) for the novice to err on the low side when choosing a speed. If that seems too slow he can then move up to the next speed.

The tendency to choose too high a speed not helped by the fact that some lathes on the market (or which may be purchased second hand) have a totally inappropriate range of speeds. (See the comments about lathes in Chapter 2.)

As he gets to know his machine, and his material, the turner begins to know almost instinctively how fast it should be rotating for a particular job. Often the sound alone will provide sufficient information. Consequently the experienced turner seldom thinks in terms of rpm or of cutting speeds. However, particularly in the case of the exercises described below, I will indicate the speed that should be used, where I think this is appropriate.

Chapter 10: Spindle turning - roughing down

10.1 Setting up

As explained earlier (see Chapter 8 Section 2) the first job to be done when undertaking a piece of spindle turning is to 'rough down' the square blank to a cylinder. For the first exercise a piece of two by two is fitted in the lathe as described in the previous chapter, the tool rest is positioned, and the lathe set to a suitable speed. For this exercise I would suggest that 2000 rpm is about right.

10.2 A Preliminary exercise

As a preliminary exercise it is a good idea to try out the tool position, and the way it is to be manipulated, with the lathe switched off. To begin with the work-piece is revolved by hand so that one of the corners is pointing roughly at the turners chest. A roughing gouge is then positioned, with the flute uppermost, so that it is supported by the rest and by the corner of the work-piece. The cutting edge of the gouge should protrude about 1in beyond that corner (see Diagram 10.1).

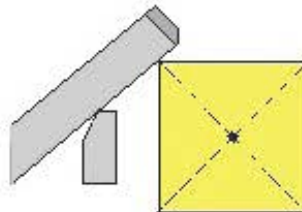

Diagram 10.1 Initial position of roughing gouge

With the tool in this position the turner should check that he will be able to take up a comfortable stance (see Chapter 6 Section 2). If the position is not comfortable the rest should be adjusted accordingly and the need for any other changes considered.

Next, the gouge should be slid back towards the turner, whilst maintaining contact with the rest and the work-piece, until the heel of the bevel comes in to contact with the corner, when the movement is stopped. (See Diagram 10.2) This action should be done several times to get the feel of the required movement.

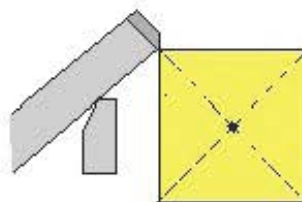

Diagram 10.2 Second position of roughing gouge

10.3 Making the cut

Now the lathe can be switched on. A point on the work-piece is chosen about 6 inches from the left hand end, the recommended stance is taken up, the grip checked, and the action described above is carried out slowly and calmly. The gouge should make contact with the rest first and then the handle is raised until the blade just touches the corners of the work-piece as they come round.

Then the gouge is drawn back until the heel of the bevel is just touching the corners. But now, instead of stopping, the gouge is withdrawn a little more, and the handle raised, until the cutting edge just comes into contact with the work-piece and begins to take tiny shavings off of the corners. The gouge is now at the position where the bevel can be said to be just rubbing (see Diagram 10.3).

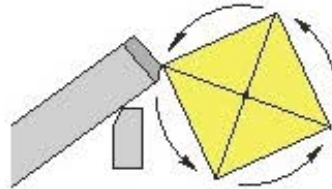

Diagram 10.3 Position of roughing gouge at start of cut

It should be noted that if this is done slowly and carefully there is absolutely no danger of anything untoward, dangerous, or worrying, taking place. So the turner should stay relaxed, but alert and in control; the way a confident car driver would be in light traffic.

We are now in the position where the gouge has taken a few small shavings off the corners of the work-piece. If that position is held the gouge will stop cutting and the turner will be able to see a slight depression in the blur made by the revolving corners. If the gouge is slid to the left, and the attitude of the tool is maintained, then the edge will again begin to take shavings. When the end of the work-piece is reached care should be taken to ensure that the cutting edge does not dip into the driving spur.

It should be noted that as the gouge is slid along the rest the initial cutting attitude must be maintained. If it is not then either the tool will stop cutting or the size of the shaving will increase. The main way to keep the tool in the right attitude is by moving the trunk of the body rather than by separate movements of the arms or hands; but, whilst doing this, it may also be necessary to control the size of the shaving by slightly raising or lowering the handle of the gouge.

10.4 Repeating the cut

When the first cut is completed the tool is returned to the initial position and the cut is repeated again and again until this part of the work-piece is reduced to a cylinder which has no flats left on it. As the cuts are repeated it will be found that, at the initial point, a sloping shoulder will be created. Although it is possible to make roughing cuts to the left or to the right it is not practical to go up a shoulder. Because of this it will be found necessary to start a little further to the left of the initial point each time and to work away from the shoulder.

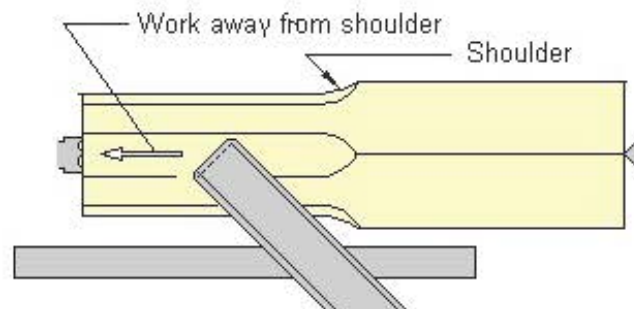
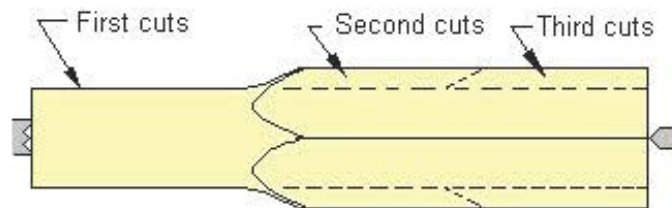

Diagram 10.4 Cuts must be taken away from the shoulder

As this section of the work-piece approaches the cylindrical form the gouge can be turned through an angle of approximately 45° (as seen from overhead) so that it is pointing in the direction it is moving (see Diagram 10.4). This change in approach enables the bevel to rub more effectively thus providing more control of the tool. It also provides a slicing cut which produces a smoother finish.

10.5 The sequence of operations

As soon as all the flats (that is, the sides of the original square) have been removed on this section the lathe is stopped. The rest is moved to a new position (if necessary) and the untouched part of the work-piece is roughed down in the same manner as before. This may be done in a number of steps, depending on the length of the



work-piece (see Diagram 10.5).

Diagram 10.5 Sequence of operations

When the roughing down has been completed, and there are no flats left on the work-piece, the profile should be reasonably straight and parallel so that a cylinder is formed. This is best achieved whilst the roughing down is taking place by trying to prevent the creation of bumps or hollows. It is particularly necessary to try to avoid hollows when the roughing down is in its final stages. Whenever a hollow is formed the rest of the surface will eventually have to be taken down to its lowest level.

As soon as a reasonably true cylinder has been formed, with no flats, the turner is ready to move onto the next exercise. The surface left by the roughing gouge in the foregoing operations will probably be quite rough. It now needs to be made nice and smooth with the planing operation (see next chapter).

10.6 The direction of the cut

I have suggested that the roughing cut should be made by moving the tool to the left. This is because I think that the beginner will find it easier to control when working in that direction. Nevertheless, it is not much more difficult to make the cut from left to right, and this does have the advantage that the shavings are then shot away from the turner.

Chapter 11: Spindle turning - the planing cut

11.1 Introduction

Many novice turners seem to think that the packaging on a new skew chisel should carry a Government Health Warning. Perhaps, because they have adopted the wrong approach, or because they have used an unsuitable tool, or because someone else has told them worrying stories, there are those who pick up the skew chisel in trepidation of something unpleasant occurring. This is very unfortunate and totally unnecessary. There is nothing to be afraid of. If the instructions given below are followed closely then nothing untoward should occur.

11.2 The chisel

It is customary to use a skew chisel to make the planing cut but a square end chisel can also be used. The skew angle does make it easier to hold the chisel in the correct cutting position. When first attempting the planing cut the novice will need a wide chisel; it is recommended very strongly that a 1 $\frac{1}{4}$ in. chisel should be used. This width makes it much easier for the turner to keep the tool cutting in the safe part of the edge. This will be discussed further below.

In addition the chisel must be sharpened correctly. This is very important. Many of the problems which people experience with the skew chisel are probably due to a badly ground tool. As a consequence I must repeat some of the points I made when discussing sharpening in Chapter 4. It is essential that the bevel of a chisel is ground either concave or, at worst, flat. I believe it will also help if the bevel angle is made fairly large; I would, in fact, recommend a bevel angle approaching 45° to start with.

Another point worth making, although it does not affect safety, is that the chisel should slide smoothly along the tool rest. It will slide more readily if the corners of the blade, which come into contact with the rest, are rounded off slightly. If it has not already been done by the manufacturer, the arris should be rounded over with a stone.

11.3 The attitude of the chisel

As a preliminary to the planing operation it is necessary to consider the attitude in which the chisel is used. This is illustrated in Diagram 11.1: the chisel is inclined at an angle so that the cutting edge is at about 45° to the axis of the lathe when seen from the view point of the turner (we can call this the angle of attack). This is the position for a right handed person who is making the cut by moving the tool from right to left, that is, towards the headstock. Note that the long point of a skew should be at the top.

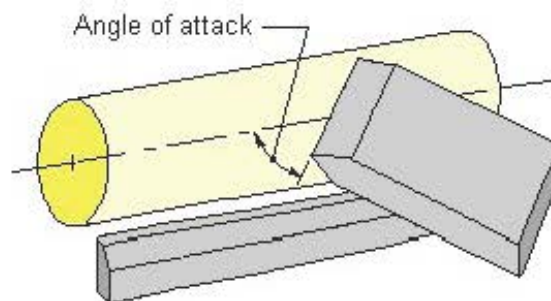

Diagram 11.1 The attitude of the chisel

Note: a square end chisel is shown in these diagrams. Whether a square end or a skew chisel is used does not matter. It is the position in which the edge is held which is important.

11.4 The cutting point

Ideally, the position on the edge, at which cutting takes place, should be about one third of the width of the edge above the short (or lower) point. For convenience, we can call the position at which cutting takes place the 'cutting point' (see Diagram 11.2). In practice it will be difficult to maintain this position precisely but every effort should be made to prevent the contact point rising above the middle point of the edge.

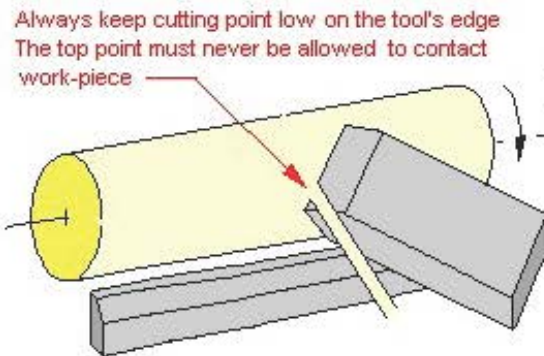

Diagram 11.1 The cutting point

What has to be emphasised is that the upper corner of the cutting edge must never be allowed to come into contact with the work-piece; if it is allowed to do so the tool will dig in and, at best, will ruin the job. Fortunately, by following the procedures described below this is easy to avoid and there will be no danger.

Although the lower point should not be allowed to come into contact with the work this does not create the same hazard. If it happens the cut will continue but a rough surface may be produced.

11.5 Preliminary exercises

With the lathe switched off procedures similar to those which I described as a preliminary exercise for the roughing down operation should be carried out. The correct stance should be taken up and the height of the tool rest adjusted so that a comfortable position can be maintained. The chisel is laid across the tool rest and the work-piece and then slid rearwards, along its own axis, until the heel of bevel is in contact with the wood. It can then be withdrawn a little further until the bevel itself is in contact with the work-piece.

At this point, with the lathe still switched off, some practice can be had in manipulating the attitude of the chisel. By making appropriate movements of the handle the turner should be able to do two things:

- adjust the angle of attack; and
- adjust the position of the cutting point on the edge of the tool.

The necessary movements should be repeated a number of times. As they are made the bevel should be held flat on the work-piece. When the lathe is running this will be when the bevel is rubbing (see Chapter 6, Section 6). Also, of course, the edge of the tool must maintain contact with the rest.

To control the tool whilst a cut is in progress the turner must be able to combine these movements. This necessitates quite subtle adjustments of the tool which on paper may seem very difficult. After a little practice, however, they are performed without conscious thought on the part of the turner. It is a little like learning to ride

a bicycle: one moment the learner is wobbling all over the road and then, suddenly he has control of balance and direction.

The movements described are actually easier to make when the cut is in progress than they are with the work-piece stationary. The small amount of vibration created by the cutting action makes it easier to slide the tool into the required positions. In addition, the resistance of the wood against the cutting edge provides some resistance, which the turner can use, to help to provide the control required. With the some practice the planing cut can readily be made with just one hand, holding the skew by the handle.

11.6 Trying out the cut

It is now time to try out the planing cut for real (ie, with the work-piece in motion) starting from the situation where roughing down has just been completed. For the time being the speed is left unchanged, ie about 2000 rpm. It may be necessary to reduce the speed later but the reasons for this will be explained in due course. The following instructions are for a right handed person.

Before the lathe is switched on think about how much of the work-piece should be planed in the first stage. It not advisable to attempt to plane the whole length in one go. In any case the tool rest may well be too short to permit that. It best to do about 6 ins at a time, starting that distance in from the left-hand end. Having chosen this position take up the recommended stance and make sure that the feet are placed in a suitable position.

The procedure to be followed in making the first cut is as follows:

- the first contact the tool makes is with the tool rest - the tip of the tool should be raised above the work-piece;
- the tip is lowered until the blade just touches the revolving corners of the wood;
- the tool is withdrawn so that the heel of the bevel makes contact with the corners;
- from this position the chisel is slowly manipulated so that the bevel is rubbing and the edge begins to cut; and then:
- the chisel is slid sideways to the left along the rest, taking a light cut to the end of the work-piece;
- this movement is produced by the body rather than the hands (see sections 6.2 and 11.7).

Care should be taken when the end is reached that the tool does not dip into the drive spur. Throughout this procedure the contact between the tool and the tool rest must be maintained.

This procedure is repeated until the work-piece has been reduced to the required diameter over the first section. When this has been achieved the adjacent section is tackled, and so on, until the right hand end of the work-piece is approached. When working to the left the last section should be started an inch or more to the left of the right hand end. This leaves a small section at the right hand end which must be tackled in a different way.

Now, for a very important point! The planing cut should not be attempted starting with the chisel off the end of the work-piece. This means that the cut must now be made in the opposite direction, that is, moving from left to right. The cut can now be made either right handed or left handed. Either way the tool must point to the right in the same attitude as before. Performed right handed this is a little awkward: the body must be twisted round so that it is between the handle of the tool and the lathe.

When the cut is performed left handed everything must be a mirror image of the attitude described above. The right hand holds the tool on the rest and the left hand holds the handle. This may seem a terrifying idea but in practice most novices do not find it too difficult. The key to success is to take it slowly and carefully. The chisel is applied to the wood so that the heel of the bevel is rubbing, slowly manipulated until the edge begins to take a fine shaving, and the cut is made to the end of the work-piece.

11.7 Possible problems

I have taken pains to stress in the foregoing the importance of keeping the bevel rubbing. Allowing the bevel to come off the work is the primary cause of all problems in turning. Whenever something seems to be going wrong the turner should check whether or not the bevel is rubbing.

The turner may find that although he can start the planing cut correctly, and maintain it for a short distance, he has difficulty in keeping the bevel rubbing. A common reason for this is that the upper body is being allowed to twist as the hands are being moved to the left. When this happens there is a tendency for the left hand to be pulled away.

The correct way to perform the cut is to keep the hands as still as possible with the elbows tucked into the sides of the body. The attitude of the tool is controlled by the hands but it is moved sideways by moving the whole of the trunk. The trunk is moved by transferring the weight of the body from the right leg to the left and allowing the pelvis to shift from above the right foot to above the left foot. As this happens the trunk, arms and hands are moved sideways en bloc, without changing their relative positions.

Another problem can be caused by the tool lifting slightly off of the rest. Sometimes this is revealed by a slight chattering of the tool and/or a slightly irregular cut. It possibly happens because the turner is concentrating so hard on keeping the bevel rubbing that he is not paying sufficient attention to other things. So, the bevel should be kept rubbing and the tool kept in contact with the rest.

11.8 Spiral ribbing

There is one problem which can occur with the planing cut even by experienced turners who, it seems, are doing everything right. The most common manifestation of this is that a series of spiral ribs are formed on the work-piece. This can be difficult to eliminate. I have come across a number of suggestions for alleviating this problem but have neither seen nor heard an explanation of what causes it.

I have my own theory about this. On many timbers there is a difference in the hardness of the early (or spring) wood, which is laid down when the sap is rising strongly, and the late (or autumn wood) when growth is slow. In ring porous timbers, such as ash and oak there is also a difference in the cellular structure of early and late wood. It is these differences which give rise to the appearance of the annual rings. In most cases the darker wood in the annual ring is harder, or cuts less readily, than the lighter areas.

When a work-piece is held between centres with the grain running axially then the annual rings will tend to run from one end to the other. When the wood is being cut a thicker shaving is taken out of the less dense wood and the work-piece goes slightly out of round. The denser, darker, wood is usually much narrower than the rest and tend to stand up as a series of ridges around the work-piece. When this effect is pronounced the ridges cause the tool to bounce slightly which in turn leads to variations in the depth of cut to form a spiral pattern.

To overcome this the natural tendency of the turner is to speed the lathe up. Certainly this was my reaction when I first encountered the problem. In fact

increasing the speed of the lathe exacerbates the problem. What happens is that the increased kinetic energy in the work-piece is transferred to the tool making it bounce even more. To put this another way: because the ridges on the work-piece are moving faster they give the tool a harder kick. As a consequence one way of dealing with this problem is to slow the lathe down.

After reducing the speed of the lathe it may be necessary to remove the bumps and hollows previously created. In this case the roughing gouge should be passed over the work again to return it to the round state. Then the planing cut can be tried again.

In some timbers, where the difference in density between the early and late wood is very pronounced, the tendency to make spiral ribs may still be evident after the speed is reduced. In this case the turner should try the following suggestions: set the rest as close to the work-piece as possible; hold the chisel more firmly than usual and, whilst making sure the bevel continues to maintain contact (ie to rub), allow it to just brush the surface.

If, after trying all these things there is still some ribbing, I have no further suggestions to make as far as the the chisel is concerned. When the exercises being described here are being followed a perfect surface is not necessary. If, when the turner has progressed and is attempting to make a specific object, it proves impossible to plane a satisfactory surface it may ultimately be necessary to resort to some very light scraping and sanding.

Some turners may find it difficult to accept that the answer to the problem of ribbing is to slow the lathe down. But remember this: no-one has to take my word for it. People can try it out for themselves and draw their own conclusions.

Chapter 12: The 'V' cut

12.1 Introduction

Having roughed down and planed the practice piece the next step is to tackle the 'V' cut. This cut is made with the corner of a chisel. Because it is made with the corner, it can be made with a chisel of almost any width. This includes the $\frac{3}{8}$ inch square beading and parting tool which can be used as a chisel for this operation. Many turners may find a narrower tool, such as this, somewhat easier to use. Nevertheless, when I am teaching I start with the $1\frac{1}{4}$ inch skew. I do this primarily to help to overcome any lingering fears the student may have concerning this tool.

A chisel has two corners, which are often called points (as they will be here). If the chisel is ground square, like the beading and parting tool, it does not matter which of the points is used for the 'V' cut; but if it is a skew then the points are formed at different angles (see Diagram 12.1). In that case the long point should be used.

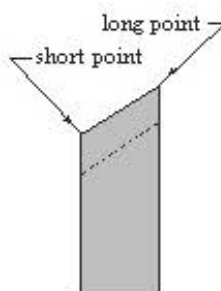

Diagram 12.1 Naming the points of the skew chisel

There are two main methods of making the 'V' cut. I call these the 'push' method and the 'swing' method. In practice these can be used in combination to form a hybrid of the two methods. I consider the swing method to be the 'proper' way of making this cut because with practise it is more natural and effective. The novice should be encouraged to persevere with it because it helps to hone skills which are required for other operations, such as forming beads, which will be described in the next chapter.

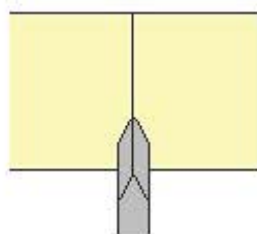

Diagram 12.2 Marking the position of the 'V'

12.2 The swing Cut

To begin this cut a very small notch is made, at the position where the 'V' is required, using the long point of the skew chisel. To prepare to do this the chisel is held with the long edge on the rest, the blade vertical, and the point well up on the

work piece but just clear of the wood. The handle is lifted so that the point swings into the wood to make a small mark and then lowered to withdraw the point (see Diagram 12.2).

Subsequent cuts are made with the chisel leaning to either side. The top edge is leaned to the left for a cut on the left side and to the right for the right side (see Diagram 12.3) Whilst the cuts are being made the slope of the cutting edge indicates the direction in which the cut should be made.

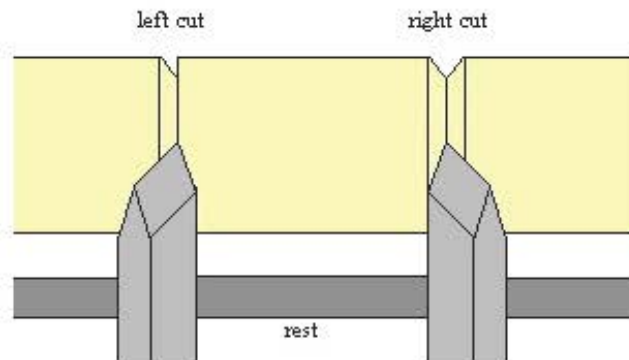

Diagram 12.3 Leaning the chisel when making a cut

At the beginning of the cut the bevel should be held at a tangent to the surface of the work piece (see Diagram 12.4).

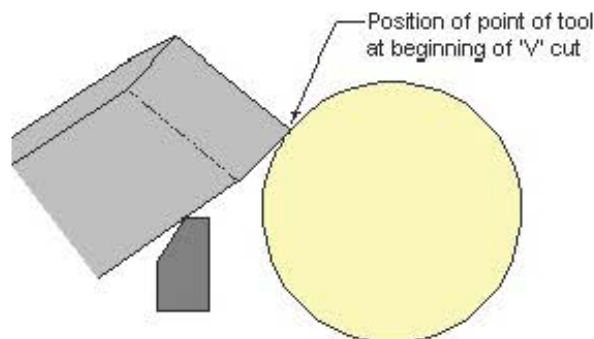

Diagram 12.4 Position of the tool when starting a cut

Assuming a cut is being made on the left side of the 'V' the handle is swung up and to the left in a straight line so that the point cuts a straight line down the side of the 'V'. In doing this the rest, of course, is used as the pivot point. This being so, it is a matter of straightforward geometry to observe that the handle must sweep through a plane which is inclined at the same angle as the side of the 'V'.

This is shown pictorially in Diagram 12.5. As the cutting point is moved from A to B the tip of the handle must move from C to D. All four points, A, B, C, and D, and the shaded area in between, lie on a single plain. Note that point D is well above point C.

The reader may think that I have laboured this point and it may seem obvious on paper, but I have found that beginners have difficulty in translating theory into

practice. What often happens is that, when observed from behind by the instructor, the tip of the handle can be seen to move in a kind of reversed 'J' movement instead of a straight line. The result is that the form of the 'V' leaves something to be desired. The beginner should try to avoid this.

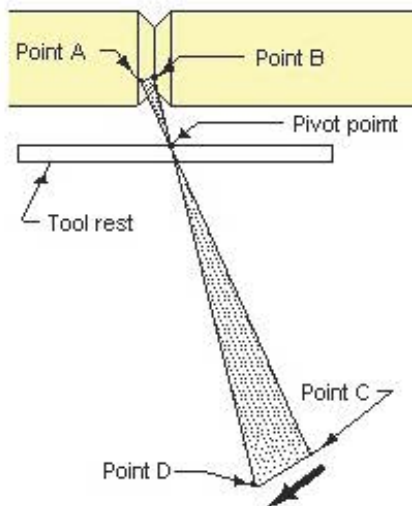
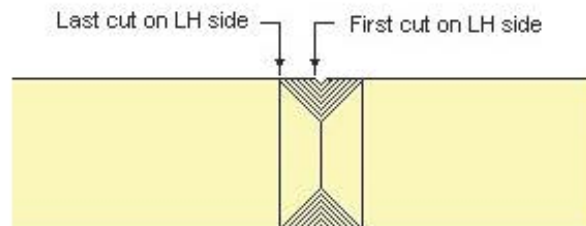

Diagram 12.5 The movement of the tool

Successive cuts start just to the side of the previous cut. Very small amounts of wood are removed with each time (see Diagram 12.6). It is customary, but not absolutely necessary, to make successive cuts on alternate sides of the 'V'. This not only enables the turner to cut away the waste cleanly but also helps to keep the 'V' in the required position. The turner should try to make each cut in a continuous sweep from the entry point to the bottom of the 'V' taking only a thin shaving. If an attempt is made to remove too much wood the point may catch. Good lighting and good eyesight are required for this. Turners wearing glasses with bifocal (or varifocal) lenses should ensure that they focus properly at the required distance.



Successive cuts start just to the side of the previous cut

Diagram 12.6 forming the 'V'

12.3 Points to note

As the 'V' gets deeper a number of points must be observed. The first is that there must be some clearance between the cutting edge of the chisel (above the cutting point) and the wall of the 'V'. This is illustrated in Diagram 12.7 which shows a view from the back of the lathe looking towards the turner. If this clearance is not maintained the edge may catch on the part of the work piece marked Point A in the diagram. The result may be an ugly spiral gash in the wood.

When Diagram 12.7 is given careful consideration it will be noted that only the lower edge of the bevel can be made to rub on the side of the 'V' (see Diagram 12.8). But this is enough to allow the turner to maintain control of the tool.

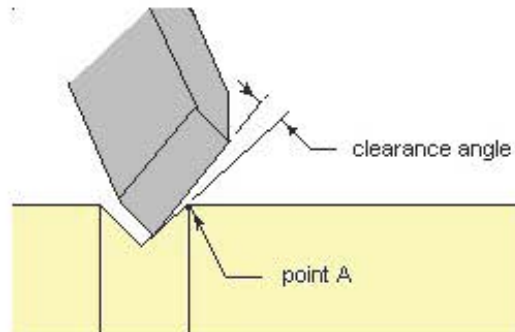

Diagram 12.7 The clearance angle

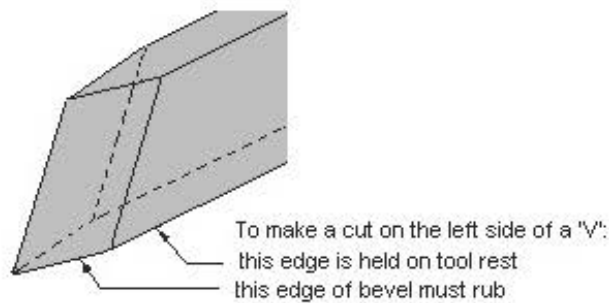

Diagram 12.8 The bevel

It should be noted that in order to keep the corner of the bevel rubbing on the side of the 'V' the tool must be pointed at an angle to the work-piece. Diagram 12.9 Shows the position for the left-hand side of the 'V'.

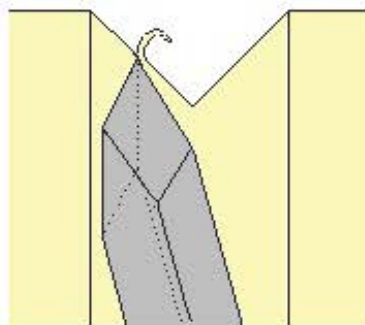

Diagram 12.9 The angle at which the tool is held for the swing cut

This angle is the opposite to that which many beginners expect. For a cut on the left-hand side of the 'V' the handle should be held to the right of the cutting point so that the edge of the bevel is more or less at a right angle to the axis of the work-piece. This can be seen by careful consideration of Diagram 12.9.

12.4 Summary of points to watch when making the swing cut

- Start the cut with the bevel rubbing (see Diagram 12.4).
- When making a cut ensure that the tool is held at the correct angle to the axis of the work-piece (when seen from above, as in Diagram 12.9).
- Keep the bevel rubbing on the wall of the 'V' (see Diagrams 12.8 and 12.9).
- Maintain the clearance angle (see Diagram 12.7).
- Move the tip of the handle in a straight line (see Diagram 12.5)

12.5 The push method

Before this cut is commenced the tool rest is positioned so that the top edge is level with the axis of the work-piece. The first cut is a small notch which is made with the long point of the skew, as was done for the swing cut. Then the tool is held in a horizontal position and, when observed from above, at an angle to the axis of the work-piece, as shown in Diagram 12.10.

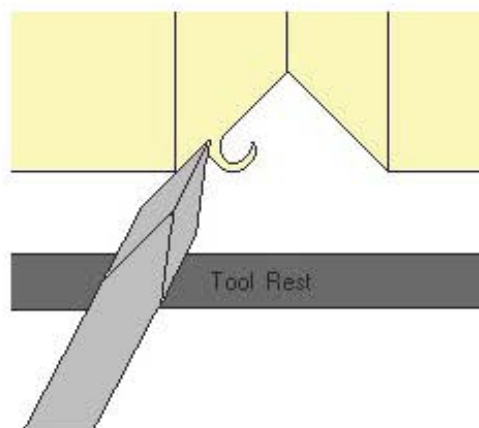

Diagram 12.10 The angle at which the tool is held for the push cut

This angle determines the slope of the side of the 'V'. To make the second cut the tool is simply pushed into the work-piece slightly to one side of the notch and penetrating a little deeper. The third cut is a repeat of the second cut but is made on the other side of the notch. These cuts can then be repeated with each successive cut on opposite sides.

12.6 A comparison of the swing and push cuts

The reader may have noted that although the swing and the push cut produce very similar results the techniques applied are very different.

If diagram 12.9 and 12.10 are compared it will be seen that, to cut the same side of the 'V', the tool is held at opposite angles. Also, whereas for the push cut the tool is held in the horizontal plane, for the swing cut the tip of the handles is held down so that the cut can be started with the bevel at a tangent to the surface of the work-piece.

When teaching beginners I find that many tend to slip into the push cut because they do not start the cut high enough on the work piece, that is, with the bevel rubbing. However, as long as the cut is made successfully, without the tool catching and ruining the work, that is not really a problem. But I do draw their attention to what is happening.

It will have been noticed that the push cut is very much easier to describe than the swing cut. In practice, however, it will not necessarily be found easier to perform. The beginner should try both methods to see which is best for him, although, as I said earlier I try to encourage students to use the swing cut.

12.7 Problems and ‘accidents’

It should be noted at this point that many novices find learning to cut both ‘V’s and beads difficult and, as a consequence, have many ‘accidents’ along the way. In this context, by an ‘accident’ I do not mean something which is physically threatening, or dangerous, to the turner, but something which damages the work. What can happen in trying to perform a ‘V’ cut or roll a bead, is that the tool catches, it then spirals out of the cut and along the work-piece forming a horrible ragged gash in the wood.

Such an accident is part and parcel of the process of learning to turn. The beginner should accept this philosophically and just keep trying. With practice these problems should occur less and less frequently.

It is often difficult to understand precisely what mistake has been made in causing this to happen. Most often it is probable that the heel of the bevel has been allowed to lift from the rubbing position. As a consequence the cutting point has penetrated too far and buried itself in the wood. As the wood continues to revolve, and the tool is supported by the rest, something has to give. That something is the wood. The edge of the tool catches and then acts as an efficient screw-cutting device, leaving the ragged spiral referred to above.

Why do beginners have problems of this kind? One reason is that the turner has to try to watch a number of things, such as keeping the bevel rubbing, maintaining the clearance angle, and controlling the speed and the direction of the cut, all at the same time. This is difficult at first and practice is required to get it all together.

If an accident does happen when practising and a spiral is cut into the work the turner should immediately start again on an undamaged part of the work piece. If an attempt is made to continue working on the damaged portion the point will probably catch again, in one of the accidental grooves, making still more of a mess.

Such an accident is part and parcel of the process of learning to turn. The beginner should accept this philosophically and just keep trying. With practise these problems should occur less and less frequently.

It is often difficult to understand precisely what mistake has been made in causing this to happen. Most often it is probable that the heel of the bevel has been allowed to lift from the rubbing position. As a consequence the cutting point has penetrated too far and buried itself in the wood. As the wood continues to revolve, and the tool is supported by the rest, something has to give. That something is the wood. The edge of the tool catches and then acts as an efficient screw-cutting device, leaving the ragged spiral referred to above.

Why do beginners have problems of this kind? One reason is that the turner has to try to watch a number of things, such as keeping the bevel rubbing, maintaining the clearance angle, and controlling the speed and the direction of the cut, all at the same time. This is difficult at first and practice is required to get it all together.

If an accident does happen and a spiral is cut into the work the turner should immediately start again on an undamaged part of the work piece. If an attempt is made to continue working on the damaged portion the point will probably catch again, in one of the accidental grooves, making still more of a mess.

Chapter 13: Cutting a bead

13.1 Which tool?

A bead can be cut with several different tools, namely: a skew chisel, a square end chisel, a beading and parting tool, and a spindle gouge, each in a number of different sizes. The problem in cutting a bead is that it is easy to get a catch; when this happens the tool is thrown back whilst cutting an ugly spiral groove in the work-piece. In this respect a spindle gouge is easier to control and less prone to produce a catch. But it does have one disadvantage, this is that the width and thickness of the tool makes it more difficult to get to the bottom of the cut without fouling the adjacent surface.

A skew chisel of virtually any size over ½ inch can be used to cut a bead. Either the long point or the short point (see Diagram 12.1 in previous Chapter) can be used. When I was learning to turn I used the long point because that was what the book I was following told me to do. The use of the short point provides a slicing cut which produces a cleaner surface; but, as the tool is rolled over in making the bead, the long point can obscure the view of the cutting point. In time I would recommend the novice to experiment with this tool trying both points.

Initially, however, I suggest that a beginner should use a ¾ inch square beading and parting tool. In effect this is a narrow, but relatively thick, square ended chisel. If this is not available a narrow square ended chisel can be used. I feel that a smaller tool is less daunting. But whichever tool is used the technique is much the same.

(For notes on the use of a spindle gouge see paragraph 13.9 below)

13.2 The nature of the cut

It is important to note that a bead can be cut either by using a corner of the chisel or by using a position on the cutting edge between the two corners, ie as when performing the planing cut. When performed by an experienced turner the use of the cutting edge produces a very clean result. (This method is shown by Richard Raffan in his video.) However, in my experience beginners are more likely to get a catch when performing the cut with the edge. As a consequence I always encourage beginners to learn the cut with the use of one of the corners. The procedure for this is described below.

13.3 The procedure

A piece of softwood, similar to that used in previous exercises, ie two by two by twelve inches long, is fixed in the lathe and the speed set to around 2000 rpm. The square is then roughed down and planed smooth.

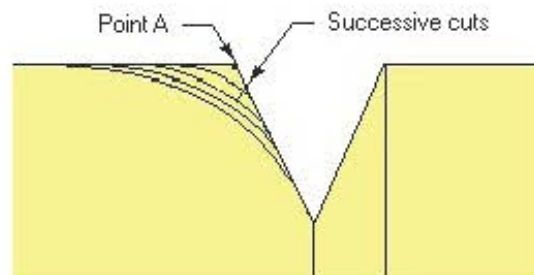

Diagram 13.1 Making a series of cuts to form a bead

Then, using the beading and parting tool, two 'V' cuts are made about 1 inch apart. These set the width of the bead and provide room for the subsequent cuts. First

one side of the bead is cut and then the other. The side of a bead is made in stages starting near the edge of the "V" and the top surface (ie point A in Diagram 13.1). We can start with the right hand side.

13.4 The bevel must rub

It is very important to note the bevel must rub throughout the cut. However, in this exercise, what I am calling the bevel is actually only the right hand edge. This is illustrated in Diagram 13.2. (This only applies when cutting with the right hand corner of the chisel on the right hand side of a bead. When cutting on the left hand side of a bead the opposite is the case.)

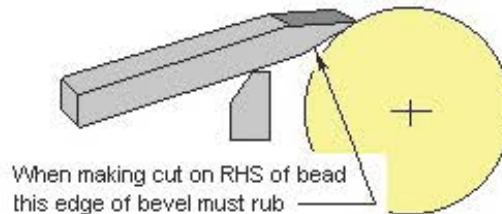

Diagram 13.2 The rubbing bevel

13.5 The first cut

The first cut is the easiest one. The starting position can be checked with the lathe switched off. The tool is placed on the rest with the cutting edge horizontal. It is then rotated, very slightly clockwise (just a few degrees), around its axis and positioned with the right hand corner of the cutting edge just to the left of point A and the bevel in the rubbing position (see Diagram 13.3).

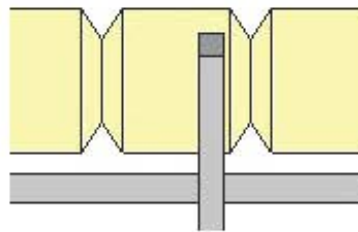

Diagram 13.3 The position of the tool for the first cut

Having switched the lathe on the first one or two cuts cut can be made just by rotating the tool around its axis. Diagram 13.4 shows that when the tool is rotated the cutting point will describe an arc. This feature can be used to cut a small radius on the corner.

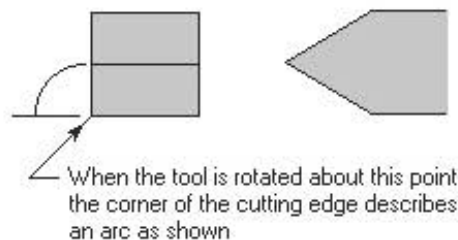

Diagram 13.4 The arc described by the cutting point

13.6 Forming the bead

After a few cuts it will be found necessary to raise the handle and slide the tool along the rest, whilst rotating the tool. The bevel is maintained in the rubbing position by pushing the tool very slightly forward. These later cuts are all performed in a similar manner as follows.

At the start of each cut the right hand corner of the cutting edge is placed just to the left of the position at which the previous cut was started with the bevel in the rubbing position but not quite cutting. Once in this position the tool is rotated around its axis so that it will begin to cut. As soon as it begins to cut the tool is slid to the right and the handle raised, whilst the rotation is continued. The objective now is to maintain the cut until it runs out into the side of the 'V' (see Diagram 13.5).

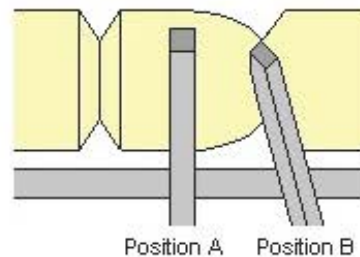

Diagram 13.5 Position of tool at beginning and end of cut

13.7 The tool must slide along the rest

Diagram 13.5 shows the position of the tool at the beginning and end of a cut on a fully shaped bead, starting in position A and finishing at position B. When it reaches position B the tool should be in the same position as it would have been at the end of a cut on the left hand side of the 'V' (when using the swing cut). This shows why the tool must be slid along the rest; it cannot get from A to B without doing so. Beginners are apt to try to perform the cut by swivelling the tool at one point on the rest. When doing this it is impossible to form a well shaped bead.

13.8 The problems to be faced

The difficulty for beginners in cutting a bead is that a number of separate actions have to be co-ordinated in the correct combination. The tool has to be rotated about its axis, the handle raised and pushed slightly forward (to keep the bevel rubbing) and the tool slid along the rest. With practice these actions become automatic but to begin with it can all seem rather difficult and it may take a little time to achieve success. The following analysis may help the beginner to appreciate what is required.

Diagram 13.6 illustrates the progression of the cut in three stages, moving from A to D through B and C.

- The lines w, X, Y and Z represent the position of the edge of the chisel cutting at points AA, BB and so on. The cutting edge is at a tangent to the surface of the wood at these points. The attitude of the cutting edge at each of these points shows that the relative speed of rotation of the tool is constant throughout the cut.
- From A to B the horizontal movement (achieved by sliding along the rest) is considerably greater than the vertical movement (achieved by raising the handle).

- From B to C the horizontal movement and the vertical movement are very similar.
- From C to D the vertical movement is greater than the horizontal movement.

In practice the rotational and sliding movements may be made at a constant rate whilst the handle is raised at an accelerating rate.

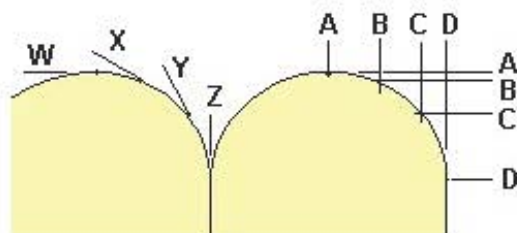

Diagram 13.6 The stages in cutting a bead

13.9 Using a spindle gouge

A spindle gouge is used in a very similar way to a chisel. The cut is made by the tip of the cutting edges. To prevent the wings of the tool catching the far wall of the 'V' cut it will be necessary to raise the handle higher than is necessary with a chisel. It also helps if the wings of the gouge are ground well back. Providing these precautions are taken it will probably be found that the gouge is the safest tool to use particularly when a catch, resulting in torn wood, would be a disaster.

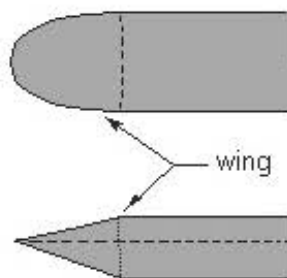

Diagram 13.7 The wings on a spindle gouge

13.10 Try, and try again

For most people, learning to cut a well shaped bead with a reasonable success rate is one of the most difficult tasks for the newcomer to woodturning. To begin with catches may occur frequently. Indeed, a number of attempts may have to be made before the first success is achieved and the bead is cut without a mishap. The reader may find it useful to re-read the comments in Section 12.7 of the previous chapter. Whatever happens keep trying, don't give up, it will come in the end. When it does it is very satisfying.

Chapter 14: Cutting a cove

14.1 Preparation

A piece of softwood, similar to that used in previous exercises, is two by two by twelve inches long, is fixed in the lathe and the speed set to around 2000 rpm. The square is then roughed down and planed smooth.

14.2 The tool

A spindle gouge of the appropriate size is used for this cut. To give some indication of the size: the width of the gouge should be about one quarter of the width of the cove to be cut. So if the width of the cove is to be 1 ½ in. a 3/8 in. spindle gouge should be employed. A beginner, practising with a limited set of tools, can make the width of the cove fit his tools, rather than the reverse.

14.3 The shape of the cove

When making actual objects coves may be all manner of shapes, providing they are some sort of hollow. From a practising point of view what one should be looking for is a nice smooth curve approaching an arc of a circle.

14.4 Marking the size of the cove

The great majority of the cutting of a cove is done with the spindle gouge but, as an initial step, it is a good idea to mark the outer extremities with the point of a chisel. There are two reasons for this:

- the marks define exactly where the cove is intended to be;
- they help to prevent the gouge skidding out of the cove and so damaging the adjacent surface.

These marks can be made with the point of any chisel (including the beading and parting tool) held with the cutting edge vertical (See Diagram 14.1). These cuts should not be very deep.

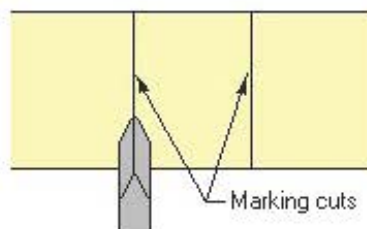

Diagram 14.1 The cuts made to mark the edges of a cove

14.5 The first stage in making the cut

To start the cut on the left side: begin by laying the tool on its back just to the right of the left-hand marking cut with the bevel rubbing (as shown in Diagram 14.2 A). Twist the tool clockwise around its axis until the tip begins to cut. Slide the tool to the right whilst maintaining the cut with the bevel continuing to rub. In order to keep the bevel rubbing it may be necessary to feed the tool forward. Stop the cut at the position midway between the two marking cuts – in other words, in the middle of the cove (Diagram 14.2 B). When this point is reached repeat the cut starting on the right-hand side. Repeat these cuts on alternate sides, always stopping in the centre, until a shape similar to that shown in Diagram 14.2 is formed. Remember that on spindle work cuts made from a larger diameter to a smaller diameter go with

the grain. In this case going with the grain is cutting from the outside of the cove to the centre.

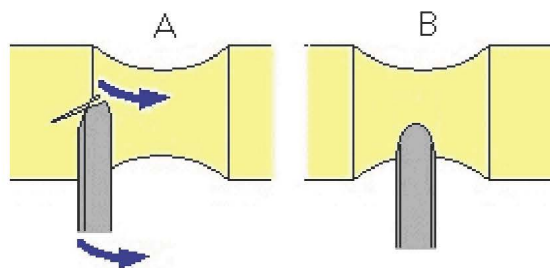

Diagram 14.2 The first stage in cutting a cove

14.6 The second stage in making cutting the cove

When the hollow of the cove has been partially formed by the method described above there comes a point at which the tool may catch and be thrown backwards along the work-piece ripping a nasty gash in the wood as it goes. This tends to happen when the sides of the cove are becoming relatively steep. Consequently once a shallow hollow has been formed a change of tactics is required. The way to prevent a catch is to ensure that at the commencement of each operation the cutting edge of the gouge is vertical as it enters the wood. If it is not vertical it acts as an efficient screw cutting device and will wind itself out of the cove. The correct attitude of the cutting edge can be achieved by watching it carefully as the tool is manipulated into position. Many beginners, however, will have problems with this. Fortunately, there is an easier way to achieving the required entry. This requires a little preparation.

14.7 Preparation for stage two

In preparation for the second stage of making the cove adjust the height of the tool rest so that when the spindle gouge is laid on its side in a horizontal position the tip of cutting edge is level with the axis of the lathe. Whilst the tool is held in the horizontal position, place a ruler across the flutes (as shown in Diagram 14.4) and turn the tool so that the ruler is in a vertical position. When the rule is vertical the cutting tip will also be vertical. This indicates the attitude in which the tool should be held at the commencement of a full cut starting from the outside of the cove.

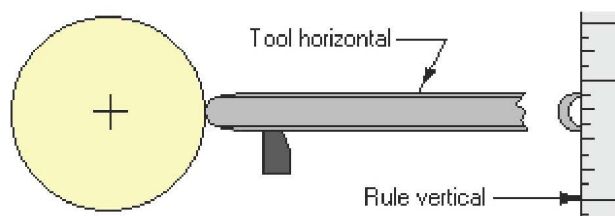

Diagram 14.3 Second stage - setting the rest

14.8 Beginning the second stage of cutting a cove

To commence the cut the gouge is held in the horizontal position (as described above), with the bevel aligned with the side of the hollow previously formed (see Diagram 14.4 A), and the tip is then entered into the wood at the edge of the cove. Immediately after the tip enters the wood the tool should be rotated around its axis, in an anti-clockwise direction, and slid along the rest towards the centre whilst, at the

same time, the handle is lowered - a twisting and scooping action. By the time the centre of the cove is reached the tool should be flat on its back and more or less at 90 degrees to the axis of the lathe (see Diagram 14.4 B). Throughout this procedure the bevel must continue to rub.

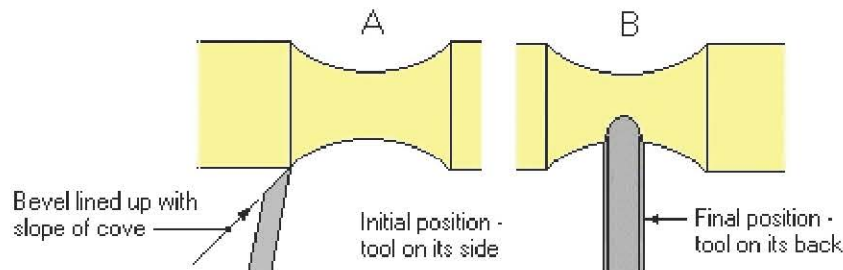

Diagram 14.4 Second stage - cutting a cove

14.9 Practising the cut with the lathe switched off

Not every one will find this cut easy to begin with. One way for beginners to get the hang of it is to try out the various positions of the tool with the lathe stopped. In preparation for this a cove of the required shape should be made as well as possible. If necessary the shape can be trued up with a round nosed scraper. Having done this the gouge should be moved carefully through the procedure checking that the bevel is rubbing the whole time.

14.10 Some further considerations

Before leaving this chapter there are some further observations to be made:

- A cut on the side of a cove does not necessarily have to be made in one continuous operation.
- When cutting a cove (or indeed any shape with a spindle gouge) the cut should be made with the leading edge of the tool.
- When cutting at the centre of the cove the fibres of the wood may not be cut cleanly.

These matters are looked at in turn below.

14.11 Discontinuous cuts

As work progresses on a cove the shape may need to be adjusted. It may, for example, be too flat on the bottom or, the opposite, too steep at the sides. In such cases material may only need to be removed from part of the cove. When starting a cut part-way into a cove the gouge should be placed in the attitude it would have been in at that point had the cut been started at the edge. That last sentence may need thinking about. The point I am hoping to make is that the gouge should be placed in such an attitude that it is pointing down the slope with the bevel rubbing.

14.12 Cutting with the leading edge of the tool

When cutting a cove the cut should be made with the leading edge of the tool. This is best explained with the aid of a diagram. In Diagram 14.5 the tool is being moved left from to right (down the slope) and is pointing slightly in the direction it is moving. The leading edge is the section emphasised. Cutting within this portion of the edge has two benefits. One is that it provides a slicing cut which severs the fibres

of the wood more cleanly. The second, and more important, is that it helps to prevent a 'dig-in'. In order to cut with the leading edge, in the attitude shown in the diagram, the tool must be twisted slightly. If, at this point, the tool should be twisted the other way (ie anti-clockwise) and the trailing edge allowed to enter the wood there will almost certainly be a nasty catch. I know this because I found out the hard way!

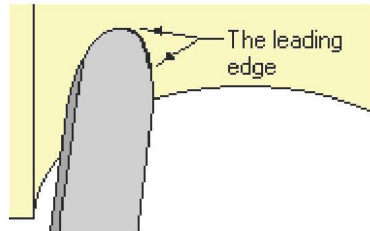

Diagram 14.5 Cutting with the leading edge of the tool

14.13 Cutting the wood in the centre of the cove

When the tool finishes a cut in the middle of the cove, as shown in Diagram 14.4 B, it will be cutting directly across the grain. In some species of wood this will result in some tearing of the fibres and a little roughness. In these cases a finishing cut be made by making a short pass over the area concerned with the gouge held at a slight angle and cutting with the leading edge, as described above.

Chapter 15: Spindle turning – the final cuts

15.1 Introduction

This chapter describes how to perform the last of the cuts to which the reader was introduced in Chapter 8. It covers the following:

- Two methods by which to form a pummel.
- How to create sections of waste wood at the extremities of the workpiece.
- How the ends of the piece can be rounded over or, alternatively, cut square (when required).
- How to part off the waste.

15.2 Forming a pummel

As indicated in Chapter 8 (Section 10) it is sometimes necessary to leave a section (or sections) of a spindle turning square. The most common reason for this is to form a leg of, say, a table or a stool, which must be jointed with rails or other members of the assembly. In such cases it is usual to plane the workpiece into a square before turning. Note that it is necessary to mount the workpiece on the lathe very accurately so that the round section will be centred in the pummel. Two main ways of cutting a pummel are described below.

15.3 Forming a pummel – method 1

One way of forming a pummel is to start by making a 'V' cut at the point where the transition from the square to the round is required. The first step is mark a pencil line all round the workpiece where the 'V' cut is to be made. The 'V' cut itself is made in exactly the same way as a 'V' cut in a round section (as described in Chapter 12). Making the cut in the square blank is more difficult because the corners cannot be seen clearly. As a consequence there is a danger of chipping the corners. It may help to put something white, such as a sheet of paper, on the bed of the lathe behind the workpiece; this may help to make the corners more visible. Note that the 'V' must be stopped immediately the bottom of the cut forms a continuous circle around the workpiece.

Having made the 'V' cut the corners on the section of the workpiece beyond the pummel can be removed with a gouge. In doing this care must be taken not to damage the corners of the pummel.

15.4 Forming a pummel – method 2

Another method of making a pummel is to use a gouge. In this case the transition from square to round is made progressively. It is done in the same way as cutting a cove but in this case only one side is formed and instead of stopping the cut is carried through to the end of the piece.

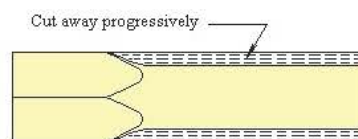

Diagram 15.1: Forming a pummel with a gouge

The cuts are repeated until the section beyond the pummel is completely circular. The method results in a differently shaped transition from the square to the circular section as compared with the previous method.

15.5 Creating the waste

Usually, when making a spindle turning, it is desirable to remove the marks made by the headstock and tailstock centres. To do this sections of waste must be formed at the extremities of the workpiece. It is customary to form this waste at an early stage of the turning so that the length of the piece can be determined accurately. In many cases forming the waste will be the first operation after the square blank has been roughed down and planed smooth. It should be noted that an allowance should be made for the waste when the blank is cut to length at the outset of the job.

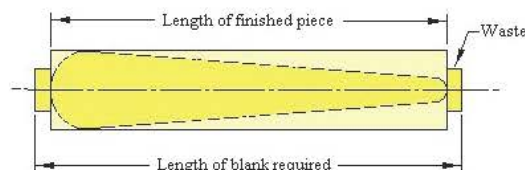

Diagram 15.2: Allowing for the waste

A section of waste is most readily created with a parting tool. First of all a nick can be made with the corner of the tool at the required distance from the end of the workpiece. Then the tool is placed on the tool rest with the cutting edge parallel to the axis of the lathe. The edge is entered into the wood high up, so that the bevel will rub. As it cuts the handle is raised and fed forward so that the bevel is maintained in the rubbing position.

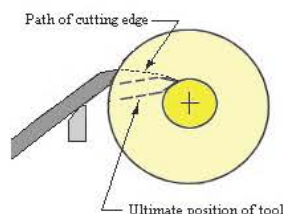

Diagram 15.3: Maintaining the bevel in the rubbing position

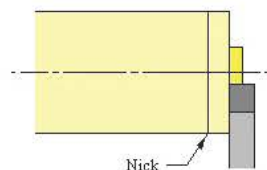

Diagram 15.4: Removing the wood in stages

The full width of the waste does not have to be removed in one operation. In order to maintain control of the tool it is often necessary to remove the material in stages, as shown in Diagram 15.4.

15.6 Rounding the end

Having created a section of waste it will often be necessary, at some stage of the turning, to round over the end of the piece. This is not difficult and is done in manner similar to that of cutting the side of a bead. The only difference is that to get the fully rounded form the handle of the tool has to be moved round farther when making the final cuts. This is because the bevel must end up more or less square to the axis of the piece.

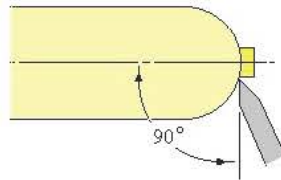

Diagram 15.5: The position of the tool at the end of the cut

15.7 Squaring the end – the conventional cut

There are occasions when the end of the piece needs to be left square and nicely finished. When the waste has been created, in the way described in Section 5 above, it will be seen that the end grain is very rough. This can be cleaned up with the corner of a chisel used in a similar manner to that employed in a 'V' cut. In this case, as the cut is to be made square to the axis of the piece, the handle of the tool has to be held further round so that the bevel will rub. The position of the tool is shown in Figure 15.6. The point is entered into the wood high up so that the bevel will rub and, to keep it rubbing, the tool is fed forward as the cut proceeds. Note that it is the lower edge of the bevel which should rub and that the cutting edge above this should lean away from the face of the wood to create a clearance angle. As with the 'V' cut only very small amounts of material can be removed with each pass of the tool.

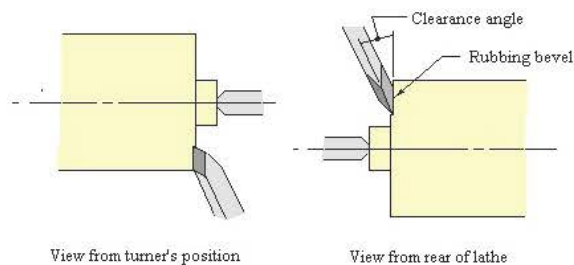

Diagram 15.6: The rubbing bevel and the clearance angle.

15.8 Squaring the end – the Raffan cut

Viewers of Richard Raffan's video will have seen that he uses a slightly different method for squaring the end. In this case immediately after the point of the chisel has entered the wood the handle is raised so that the wood is cut, not with the corner, but with the cutting edge (see Diagram 15.7).

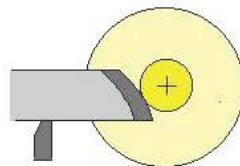

Diagram 15.7: The Raffan method

Using this method the edge of the tool cannot be allowed to lean away from the wood to form a clearance angle as described above. Because of this I think most beginners will find it more difficult than the conventional method particularly when performed with a skew with a straight edge. It may have been noticed that Raffan uses an oval skew ground with a curved edge (see Chapter 3, Diagram 3.5). The advantage of this, for this operation, is that the combination of the oval section and

the curved edge brings the points away from the wood. In effect this produces small clearance angles above and below the position on the edge where the wood is being cut; this reduces the danger of a catch.

15.9 The parting cut

In Section 15.2 above the way the waste is created was explained. Now it is necessary to consider how the waste is removed. It is, perhaps, somewhat paradoxical that a tool known as a parting tool is rarely used by an experienced turner for the final act of parting-off. Instead this is commonly done with a chisel. My favourite tool for this job is the chisel with a square section (also known as a beading and parting tool). Sometime, when space is very limited, I use small skew chisel. These are personal preferences, however, and any chisel, skewed or square ended, can be used.

The method, in a nutshell, is to make a 'V' cut on the (imaginary) line which forms the end of the piece. In many cases the side of the 'v' which is on the end of the piece will need to be more or less square to the axis. What it will need to do is conform to the required shape. (See Diagram 15.8.)

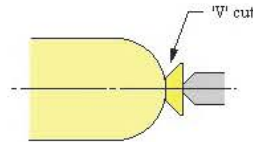

Diagram 15.8: Parting off

When the waste has to be removed at both ends of the piece I always start at the tailstock. I make the 'V' cut as deep as I dare without risking the waste breaking off prematurely. If it does break off at this stage it will mean that the waste at the headstock end will have to be sawn off and there will be a lot of hand finishing to do.

How deep the 'V' cut at the tailstock can be made without the waste breaking off is, of course, a matter of judgement; but a lot depends on the species of wood. On many hardwoods the material remaining can be reduced to a few fibres, but softwoods break more readily. A good strategy is to cut the 'V' as deep as possible whilst leaving enough material to be reasonably certain that there is no danger of premature breakage. Then to go the headstock end and do the same thing there. Having done that return to the tailstock end and remove a little more material. The objective is to cut away enough so that when the piece is taken off the lathe the waste can easily be broken off with the fingers. However, if the too much is turned away and the waste does break off prematurely, there will not be quite so much handwork to be done on the headstock end.

Now, assuming the work on the tailstock end has been completed without an 'accident' the waste at the headstock end can now be cut off completely. The 'V' is made progressively deep until the point is approaching at which the waste will break off. At this point the forward hand (the left hand of a right handed turner) is placed loosely around the end of the revolving workpiece. Using the tool one handed the 'V' cut is continued until the wood breaks and the piece drops into the hand waiting to catch it.

OK: to the novice the last few sentences should raise some doubts and a little apprehension. Fear not; until such time as you have enough confidence to carry out this procedure just make the 'V' cut at each end as deep as you dare and then cut the waste pieces off with a saw. That's it.